

ORDER EXAMPLE To correctly order this model follow the example specified below:

PRODUCT	SHV#200 005 R05 ST 9010 R12 COP 9010
SHV#200 005	Article code composed of Model, Height (200) and Number of elements (005)
R05	Connector code found in the table here below
ST	Standard Support code found in the table here below
9010	Colour code to be checked in the Tubes Colour Chart
R12	Connection code that defines the type of union for copper pipes or multi-layer pipes found herein at page 276
COP9010	Standard covering code and relative finish to be checked in the Tubes Colour Chart. The standard option provided is a standard covering and an aesthetic covering – both interchangeable – supplied without additional price charge with the same finish as the radiator ordered. For further information on possible variants see the table in the following page.

ACCESSORIES

Cod. GVR	One way Remote Valve Assembly, CHROME finish
Cod. GVRC#*	One way Remote Valve Assembly, COLOUR finish*

* Specify the color code, e.g.: 9010, after checking the Tubes Colour Chart

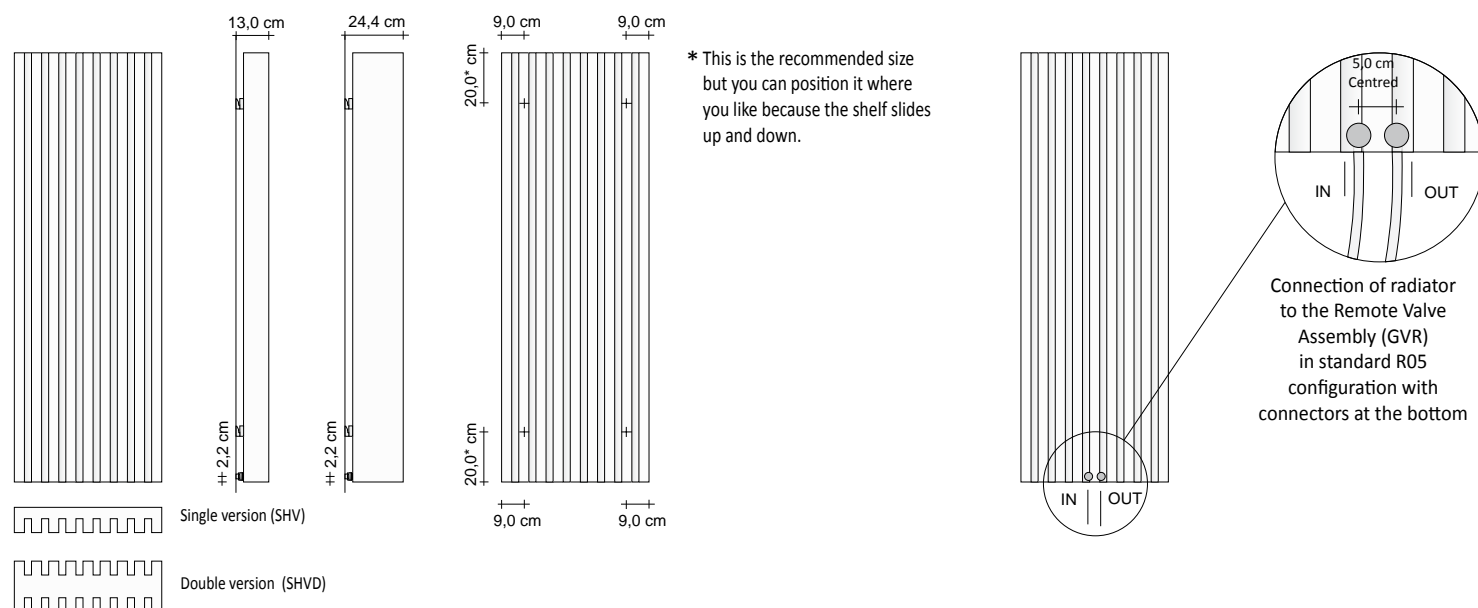

REAR CONNECTORS

They enable connection to the system via Remote Valve Assembly (GVR) which are supplied as an accessory. This type of connectors must be specified when placing the order, they are supplied WITHOUT an additional price charge

EXTERNAL CONNECTORS – standard type

They enable connection to the system via Standard Valve and Lockshield which are supplied as an accessory. This type of connectors must be specified when placing the order, they are supplied WITH an additional price charge of €
The center of the valve compared to the wall is 5 cm for SHV, for SHVD 14,4 cm

Standard connector R05
below at 5 cm

connector RS1
Left side connection

connector RD1
Right side connection

Connector on request C05
Bottom connection - 5 cm centered

connector B2M
External bottom connection - CUSTOM MADE

Connector on request OS2
Left side connection

Connector on request OD2
Right side connection

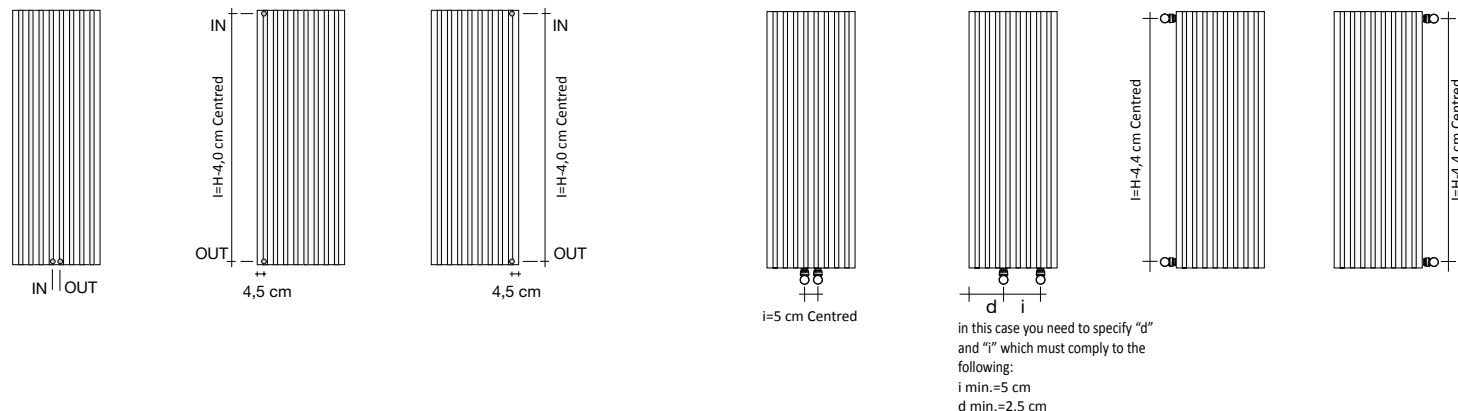

ADDITIONAL CHARGES FOR COLOURS AND FINISHES (see the official Tubes Colour Chart)

Additional colour charges are calculated over the Pure white price (Cat. C0), for the other categories the additional charges herein below are applicable: Category C1 and C2 +10% - C3 Category +20% -

RAL not included in the colour chart +30%. According to samples : Request feasibility and cost estimate. Colours not available: GRGR.

SOHO VERTICAL

Single and double low water content radiator composed of vertical elements entirely made of anodized aluminium

VERTICAL SINGLE

Height		60			80			100			140			160		
N° elements	Width (cm)	Watts ΔT 50°C	Watts ΔT 30°C	Price (€)	Watts ΔT 50°C	Watts ΔT 30°C	Price (€)	Watts ΔT 50°C	Watts ΔT 30°C	Price (€)	Watts ΔT 50°C	Watts ΔT 30°C	Price (€)	Watts ΔT 50°C	Watts ΔT 30°C	Price (€)
3	17,6	279	143		353	181		424	216		559	282		623	313	
4	24,4	371	191		471	241		566	289		745	376		831	418	
5	31,2	464	238		588	301		707	361		931	470		1038	522	
6	38,0	557	286		706	361		848	432		1117	564		1246	626	
7	44,8	650	334		824	422		990	505		1304	659		1453	730	
8	51,6	743	382		942	482		1131	577		1490	753		1661	835	
9	58,4	836	430		1059	542		1272	649		1676	846		1869	939	
10	65,2	928	477		1177	603		1414	721		1862	940		2076	1043	
11	72,0	1021	525		1295	663		1555	793		2049	1035		2284	1148	
12	78,8	1114	573		1412	723		1697	865		2235	1129		2492	1253	
13	85,6	1207	620		1530	783										
14	92,4	1300	668		1648	844										
15	99,2	1393	716		1765	904										
16	106,0	1485	763		1883	964										
17	112,8	1578	811		2001	1024										
18	119,6	1671	859		2118	1084										
19	126,4	1764	907		2236	1145										
20	133,2	1857	954		2354	1205										

Height		180			200			220			240			280		
N° elements	Width (cm)	Watts ΔT 50°C	Watts ΔT 30°C	Price (€)	Watts ΔT 50°C	Watts ΔT 30°C	Price (€)	Watts ΔT 50°C	Watts ΔT 30°C	Price (€)	Watts ΔT 50°C	Watts ΔT 30°C	Price (€)	Watts ΔT 50°C	Watts ΔT 30°C	Price (€)
3	17,6	686	345		747	376		806	407		865	437		1009	511	
4	24,4	914	460		995	501		1075	543		1153	583		1345	681	
5	31,2	1143	575		1244	627		1344	678		1442	729		1682	851	
6	38,0	1371	690		1493	752		1613	814		1730	874		2018	1021	
7	44,8	1600	805		1742	878		1882	950		2018	1020		2355	1192	
8	51,6	1828	920		1991	1003		2150	1085		2307	1166		2691	1362	
9	58,4	2057	1035		2240	1129		2419	1221		2595	1311		3027	1532	
10	65,2	2285	1150		2489	1254		2688	1357		2883	1457		3364	1702	
11	72,0	2514	1265		2738	1380		2957	1492		3172	1603		3700	1872	
12	78,8	2742	1380		2986	1505		3226	1628		3460	1748		4036	2042	

VERTICAL DOUBLE

Height		60			80			100			140			160		
N° elements	Width (cm)	Watts ΔT 50°C	Watts ΔT 30°C	Price (€)	Watts ΔT 50°C	Watts ΔT 30°C	Price (€)	Watts ΔT 50°C	Watts ΔT 30°C	Price (€)	Watts ΔT 50°C	Watts ΔT 30°C	Price (€)	Watts ΔT 50°C	Watts ΔT 30°C	Price (€)
3	17,6	436	225		548	283		653	337		851	435		945	482	
4	24,4	582	301		730	377		871	449		1135	581		1260	642	
5	31,2	727	376		913	471		1089	561		1419	726		1575	803	
6	38,0	872	451		1096	566		1307	674		1703	871		1891	964	
7	44,8	1018	526		1278	660		1525	786		1987	1017		2206	1125	
8	51,6	1163	601		1461	754		1743	898		2271	1162		2521	1285	
9	58,4	1309	676		1644	848		1960	1010		2554	1307		2836	1446	
10	65,2	1454	751		1826	942		2178	1123		2838	1452		3151	1606	
11	72,0	1599	826		2009	1037										
12	78,8	1745	902		2191	1131										

Height		180			200			220			240		
N° elements	Width (cm)	Watts ΔT 50°C	Watts ΔT 30°C	Price (€)	Watts ΔT 50°C	Watts ΔT 30°C	Price (€)	Watts ΔT 50°C	Watts ΔT 30°C	Price (€)	Watts ΔT 50°C	Watts ΔT 30°C	Price (€)
3	17,6	1036	529		1125	575		1211	620		1295	663	
4	24,4	1382	705		1500	767		1615	826		1727	885	
5	31,2	1727	882		1875	958		2018	1032		2159	1106	
6	38,0	2073	1058		2250	1150		2422	1239		2591	1327	
7	44,8	2418	1234		2625	1341							
8	51,6	2763	1410		2999	1533							

COVERINGS

Ordered with the radiator

Ordered after the Radiator

Description	Code	Price (€)	Code	Price (€)
Punched aesthetic covering with a different colour from the radiator	FOR (COL.FIN*)		COPSHEDF#..FOR....	
Punched aesthetic covering with Galvanized finish (e.g.: Chrome, Gold...)	FOR (COL.FIN*)		COPSHEDFG#..FOR....	
CLOSED aesthetic covering with the same colour as the radiator	COP (COL.FIN*)	-		-
CLOSED aesthetic covering with a different colour from the radiator	COP (COL.FIN*)		COPSHE#..COP....	
CLOSED aesthetic covering with Galvanized finish (e.g.: Chrome, Gold...)	COP (COL.FIN*)		COPSHEG#..COP....	

* Colour/finish means you have to indicate the code of colour or finish required

REMOTE VALVE ASSEMBLY

Valve and Lockshield assembly for remote connection (GVR), can be installed up to a maximum distance of 6 metres from the radiator.

Connection of Remote Valve Assembly (GVR) to water system

Code	Description	Finishes	Price (€)
GVR#	RECESSED valve and lockshield assembly for remote connection	CHROME	
GVRC#	RECESSED valve and lockshield assembly for remote connection	COLOUR	

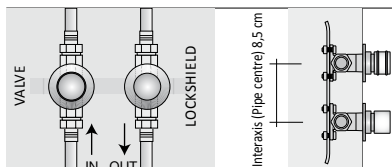

ORDER EXAMPLE To correctly order this model follow the example specified below:

PRODUCT	SHO#200 005 OR1 ST 9010 R12 COP 9010
SHO#200 005	Article code composed of Model, Width (200) and Number of elements (005)
OR1	Connector code found in the table here below
ST	Standard Support code found in the table here below
9010	Colour code to be checked in the Tubes Colour Chart
R12	Connection code that defines the type of union for copper pipes or multi-layer pipes found herein at page 276
COP9010	Standard covering code and relative finish to be checked in the Tubes Colour Chart. For further information on possible variants see the table in the following page.

ACCESSORIES

Cod. GVR	One way Remote Valve Assembly, CHROME finish
Cod. GVRC#*	One way Remote Valve Assembly, COLOUR finish*

* Specify the color code, e.g.: 9010, after checking the Tubes Colour Chart

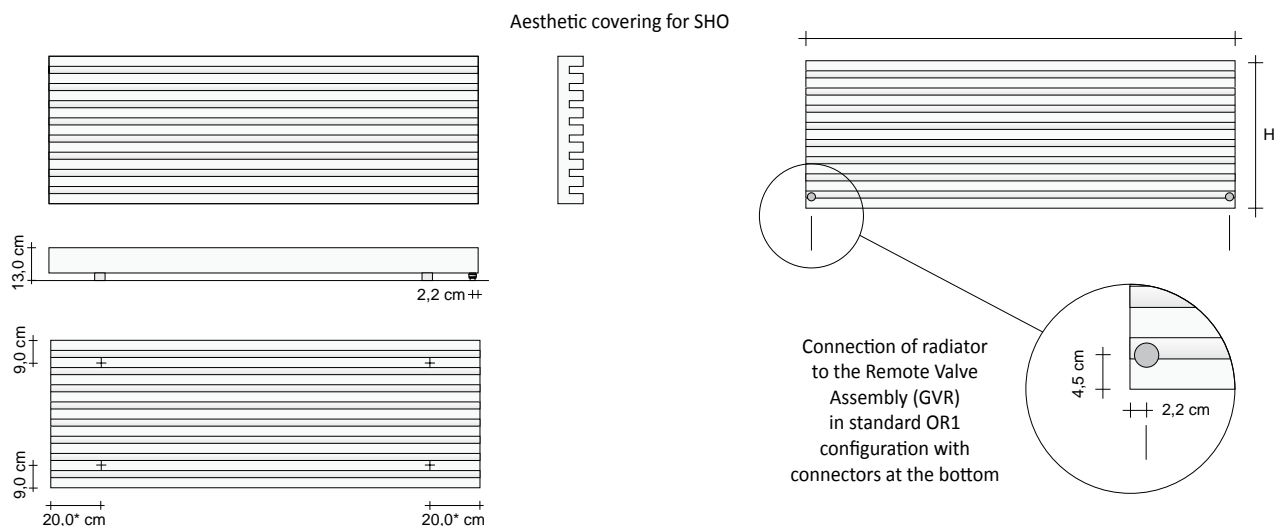

* This is the recommended size but you can position it where you like because the shelf slides up and down.

Standard REAR CONNECTORS

They enable connection to the system via Remote Valve Assembly (GVR) which are supplied as an accessory. This type of connectors must be specified when placing the order, they are supplied WITHOUT an additional price charge

EXTERNAL CONNECTORS – standard type

They enable connection to the system via Standard Valve and Lockshield which are supplied as an accessory. This type of connectors must be specified when placing the order, they are supplied WITH an additional price charge of €

Standard connector

OR1

standard connector always supplied, if not otherwise specified in the order

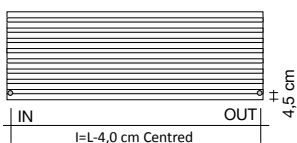

connector OB2

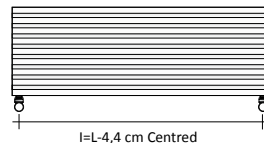

connector RS2

Supplied on request without an additional price charge

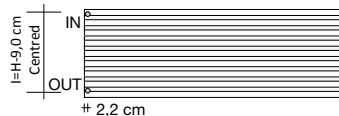

connector RD2

Supplied on request without an additional price charge

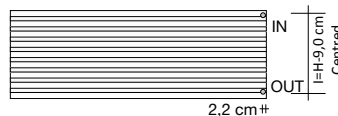

ADDITIONAL CHARGES FOR COLOURS AND FINISHES (see the official Tubes Colour Chart)

Additional colour charges are calculated over the Pure white price (Cat. C0), for the other categories the additional charges herein below are applicable: Category C1 and C2 +10% - C3 Category +20% - RAL not included in the colour chart +30%. According to samples : Request feasibility and cost estimate. Colours not available: GRCR.

SOHO HORIZONTAL

Single low water content radiator composed of horizontal elements entirely made of aluminium

Width		60			80			100			140			160		
N° elements	Height (cm)	Watts ΔT 50°C	Watts ΔT 30°C	Price (€)	Watts ΔT 50°C	Watts ΔT 30°C	Price (€)	Watts ΔT 50°C	Watts ΔT 30°C	Price (€)	Watts ΔT 50°C	Watts ΔT 30°C	Price (€)	Watts ΔT 50°C	Watts ΔT 30°C	Price (€)
3	17,6	146	79		195	106		243	132		341	185		389	211	
4	24,4	195	105		260	140		325	175		454	245		519	280	
5	31,2	234	126		312	167		390	209		545	292		623	334	
6	38,0	273	146		364	194		455	243		636	339		727	388	
7	44,8	318	166		424	221		530	277		742	387		848	443	
8	51,6	362	188		482	251		603	314		844	439		965	502	
9	58,4	405	210		540	280		675	350		946	491		1081	561	
10	65,2	451	236		602	314		752	393		1053	550		1203	628	
11	72,0	500	264		667	352		834	440		1167	616		1334	704	
12	78,8	549	293		732	390		915	488		1281	683		1464	780	

Width		180			200			220			240			280		
N° elements	Height (cm)	Watts ΔT 50°C	Watts ΔT 30°C	Price (€)	Watts ΔT 50°C	Watts ΔT 30°C	Price (€)	Watts ΔT 50°C	Watts ΔT 30°C	Price (€)	Watts ΔT 50°C	Watts ΔT 30°C	Price (€)	Watts ΔT 50°C	Watts ΔT 30°C	Price (€)
3	17,6	438	237		487	264		536	291		584	317		682	370	
4	24,4	584	315		649	350		714	385		779	420		909	490	
5	31,2	701	376		779	418		857	460		935	502		1091	585	
6	38,0	818	437		909	485		1000	534		1091	582		1273	679	
7	44,8	954	498		1061	554		1167	609		1273	665		1485	775	
8	51,6	1085	565		1206	628		1326	690		1447	753		1688	878	
9	58,4	1216	631		1351	701		1486	771		1621	841		1891	981	
10	65,2	1354	707		1504	786		1655	864		1805	943		2106	1100	
11	72,0	1500	791		1667	879		1834	968		2000	1055		2334	1231	
12	78,8	1647	878		1830	975		2013	1073		2196	1170		2562	1365	

COVERINGS

Ordered with the radiator

Ordered after the Radiator

Description	Code	Price (€)	Code	Price (€)
CLOSED aesthetic covering with the same colour as the radiator	COP (COL.FIN*)	-		-
CLOSED aesthetic covering with a different colour from the radiator	COP (COL.FIN*)		COPSHE#..COP...	
CLOSED aesthetic covering with Galvanized finish (e.g.: Chrome, Gold...)	COP (COL.FIN*)		COPSEHG#..COP...	

* Colour/finish means you have to indicate the code of colour or finish required

REMOTE VALVE ASSEMBLY

Valve and Lockshield assembly for remote connection (GVR), can be installed up to a maximum distance of 6 metres from the radiator.

Connection of Remote Valve Assembly (GVR) to water system

Code	Description	Finishes	Price (€)
GVR#	RECESSED valve and lockshield assembly for remote connection	CHROME	
GVRC#	RECESSED valve and lockshield assembly for remote connection	COLOUR	

For the GVR code you must specify the colour required
The external finish of the GVR is only Glossy Chrome-plated

SOHO BATHROOM - COLOURED & ANODIZED

Single low water content radiator composed of vertical elements entirely made of aluminium

HW

ORDER EXAMPLE To correctly order this model follow the example specified below:

PRODUCT	SHVB#140 007 C5B ST BNOP R12 COP BNOP
SHVB#140 007	Article code composed of Model, Height (140) and Number of elements (007), see price-list table
C5B	Code of standard connector supplied unless otherwise specified in the order, for connector options consult SHV connectors
ST	Standard Support code
BNOP	The standard colour code is BNOP Matt white, for other colours see the Tubes Colour Chart
R12	Connection code that defines the type of union for copper pipes or multi-layer pipes found herein at page 276
COP_BNOP	Standard covering code and relative finish, standard colour is matt white (BNOP), for other colours see the Tubes Colour Chart. For further information on possible variants see the table in the following page.

ACCESSORIES

- Remote Valve Assembly
- Two standard valves
- Only one valve with 5 cm Interaxis (Pipe centre)

Check valve codes and prices in the table on the side

POSSIBLE CONNECTORS

SOHO for Bathrooms is available with rear connectors for connection to the Remote Valve Assembly (GVR), or with double C5B connector for standard valves, with either 5 cm centered Interaxis (Pipe centre) or with specific «S» Interaxis (Pipe centre). These types of connectors must be specified when ordering and they are supplied WITHOUT an additional price charge.

Connector on request R05
Rear connection - 5 cm centered. Needs to be mounted with a Remote Valve Assembly (GVR), supplied as an accessory.

Standard Connector C5B
Double connector with bottom connection, either 5 cm centered or "s" Interaxis (Pipe centre) of towel warmer – valves not included

SOHO BATHROOM - COLOURED & ANODIZED

Single low water content radiator composed of vertical elements entirely made of aluminium

HW

Code	H (cm)	L (cm)	Coloured version		Anodized version		Anodized (€)	Matt white (€)
			Watts ΔT 50°C	Watts ΔT 30°C	Watts ΔT 50°C	Watts ΔT 30°C		
SHVB#070005	70,0	31,2	526	270	473	243		
SHVB#070007	70,0	44,8	737	379	663	341		
SHVB#070008	70,0	51,6	842	433	758	389		
SHVB#110005	110,0	31,2	778	397	700	357		
SHVB#110007	110,0	44,8	1089	555	980	500		
SHVB#110008	110,0	51,6	1244	634	1120	571		
SHVB#130005	130,0	31,2	865	437	779	393		
SHVB#130007	130,0	44,8	1210	611	1089	550		
SHVB#130008	130,0	51,6	1383	699	1245	629		
SHVB#170005	170,0	31,2	1090	548	981	493		
SHVB#170007	170,0	44,8	1523	766	1371	689		
SHVB#170008	170,0	51,6	1744	877	1570	789		

SOHO for Bathrooms is available 7 days from the date of order in Matt white code BNOP with C5B connector.
In the Anodized version the code SHVB# becomes SHVBA#.

ADDITIONAL COLOUR CHARGE (see the official Tubes Colour Chart)

Additional color charges are calculated over the Matt white price, for the other categories refer to the additional price charges found here below: Category C1 and C2 +10% - C3 Category +20% - RAL not included in the colour chart +30% - According to samples : Request feasibility and cost estimate.

ANODIZATIONS

The prices found in the table refer to Anodized Silver Aluminium finish. For the Anodized BLACK, GREY TITANIUM and BRONZE version + 10%

Description	Ordered with the radiator		Ordered after the Radiator	
	Code	Price (€)	Code	Price (€)
CLOSED aesthetic covering with the same colour as the radiator	COP (COL.FIN*)	-		-
CLOSED aesthetic covering with a different colour from the radiator	COP (COL.FIN*)		COPSHE#..COP...	
CLOSED aesthetic covering with Galvanized finish (e.g.: Chrome, Gold...)	COP (COL.FIN*)		COPSHEG#..COP....	

* Colour/finish means you have to indicate the code of colour or finish required

REMOTE VALVE ASSEMBLY

Valve and Lockshield assembly for remote connection (GVR), can be installed up to a maximum distance of 6 metres from the radiator.

Connection of Remote Valve Assembly (GVR) to water system

		Code	Description	Finishes	Price (€)
		GVR#	RECESSED valve and lockshield assembly for remote connection	CHROME	
		GVRC#	RECESSED valve and lockshield assembly for remote connection	COLOUR	

For the GVRC code you must specify the colour required
The external finish of the GVR is only Glossy Chrome-plated

Standard VALVES (for Valves and Lockshields, valves that can be fitted with thermostat, Thermostatic valves, or Single pipe, Twin pipe, Stainless steel and thermostatic heads see pages 271 - 272 - 273 - 274 - 275)

Code / Description	Finishes	Price (€)
 Z1TLNR#ANR129010 Paired Valve and Lockshield copper Angle 1/2"	WHITE	
 Z1RAC#R12CRO 2 copper unions diam. 12 mm	CHROME	
 ZRCF# Kit with pipe collars for towel warmers	WHITE	

Code / Description	Price (€) 9010	Price (€) Chrome
 Z1TLSNR#ANR12SX... Valves with 5 cm Interaxis (Pipe centre) 5 cm - Left		
 Z1TLSNR#ANR12DX... Valves with 5 cm Interaxis (Pipe centre) 5 cm - Right		

ORDER EXAMPLE To correctly order this model follow the example specified below:

PRODUCT	SHVA#200 005 R05 ST ANAR R12 COPCRO
SHVA#200 005	Article code composed of Model, Height (200) and Number of elements (005)
R05	Connector code found in the table here below
ST	Standard Support code found in the table here below
ANAR	Colour code to be checked in the Tubes Colour Chart
R12	Connection code that defines the type of union for copper pipes or multi-layer pipes found herein at page 276
COPCRO	Standard covering code and relative finish to be checked in the Tubes Colour Chart. For further information on possible variants see the table in the following page.

ACCESSORIES

Cod. GVR	One way Remote Valve Assembly, CHROME finish
Cod. GVRCH*	One way Remote Valve Assembly, COLOUR finish*

* Specify the color code, e.g.: 9010, after checking the Tubes Colour Chart

Height	N° elements	Width (cm)	70				110				130				170			
			Water Content (l)	Watts ΔT 50°C	Watts ΔT 30°C	Price (€)	Water Content (l)	Watts ΔT 50°C	Watts ΔT 30°C	Price (€)	Water Content (l)	Watts ΔT 50°C	Watts ΔT 30°C	Price (€)	Water Content (l)	Watts ΔT 50°C	Watts ΔT 30°C	Price (€)
3	17,6	0,68	285	146		0,99	420	214		1,21	467	236		1,61	588	296		
4	24,4	0,90	380	195		1,32	560	286		1,61	622	314		2,15	784	394		
5	31,2	1,13	475	244		1,65	700	357		2,01	778	393		2,69	980	493		
6	38,0	1,35	570	293		1,98	840	428		2,41	934	472		3,22	1176	591		
7	44,8	1,58	665	342		2,31	980	500		2,81	1089	550		3,76	1372	690		
8	51,6	1,80	760	391		2,64	1120	571		3,22	1245	629		4,30	1568	788		
9	58,4	2,03	855	439		2,97	1260	643		3,62	1400	707		4,83	1764	887		
10	65,2	2,25	950	488		3,30	1400	714		4,02	1556	786		5,37	1960	985		
11	72,0	2,48	1045	537		3,63	1540	785		4,42	1712	864		5,91	2156	1084		
12	78,8	2,70	1140	586		3,96	1680	857		4,82	1867	943		6,44	2352	1182		

The prices found in the table refer to Anodized Silver Aluminium finish. For the Anodized BLACK, GREY TITANIUM and BRONZE version + 10%

REAR CONNECTORS

They enable connection to the system via Remote Valve Assembly (GVR) which are supplied as an accessory. This type of connectors must be specified when placing the order, they are supplied WITHOUT an additional price charge

Standard connector R05

below at 5 cm

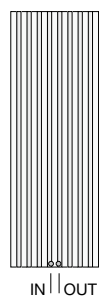

connector RS1

Left side connection

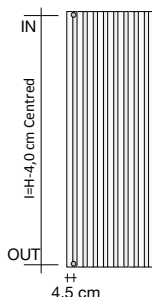

connector RD1

Right side connection

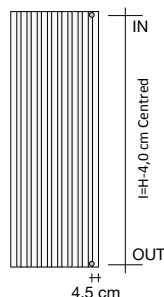

EXTERNAL CONNECTORS – standard type

They enable connection to the system via Standard Valve and Lockshield which are supplied as an accessory. This type of connectors must be specified when placing the order, they are supplied WITH an additional price charge of €

The center of the valve compared to the wall is 5 cm for SHV, for SHVD 14,4 cm

Connector on request C05

Bottom connection - 5 cm centered

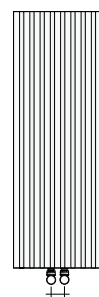

I=5 cm Centred

connector B2M

External bottom connection - CUSTOM MADE



in this case you need to specify "d" and "i" which must comply to the following:
i min.=5 cm
d min.=2,5 cm

Connector on request OS2

Left side connection



I=H-4,4 cm Centred

Connector on request OD2

Right side connection

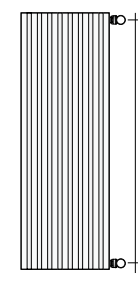

I=H-4,4 cm Centred

Aesthetic covering for SHV



COVERINGS

Description	Ordered with the radiator		Ordered after the Radiator	
	Code	Price (€)	Code	Price (€)
CLOSED aesthetic covering with the same colour as the radiator	COP (COL.FIN*)	-		
CLOSED aesthetic covering with a different colour from the radiator	COP (COL.FIN*)		COPSHE#..COP...	

* Colour/finish means you have to indicate the code of colour or finish required

SOHO HORIZONTAL ANODIZED

Single low water content radiator composed of horizontal elements entirely made of anodized aluminium

HW

ORDER EXAMPLE To correctly order this model follow the example specified below:

PRODUCT SHOAH#200 005 OR1 ST ANAR R12 COP CRO
 Article code composed of Model, Width (200) and Number of elements (005)
 OR1 Connector code found in the table here below
 ST Standard Support code found in the table here below
 ANAR Colour code to be checked in the Tubes Colour Chart
 R12 Connection code that defines the type of union for copper pipes or multi-layer pipes found herein at page 276
 COPCRO Standard covering code and relative finish to be checked in the Tubes Colour Chart. For further information on possible variants see the table in the following page.
 Cod. GVR One way Remote Valve Assembly, CHROME finish
 Cod. GVRC#* One way Remote Valve Assembly, COLOUR finish*
 * Specify the color code, e.g.: 9010, after checking the Tubes Colour Chart

Width		70				110				130				170			
N° elements	Height (cm)	Water Content (l)	Watts ΔT 50°C	Watts ΔT 30°C	Price (€)	Water Content (l)	Watts ΔT 50°C	Watts ΔT 30°C	Price (€)	Water Content (l)	Watts ΔT 50°C	Watts ΔT 30°C	Price (€)	Water Content (l)	Watts ΔT 50°C	Watts ΔT 30°C	Price (€)
3	17,6	0,68	185	100		0,99	231	125		1,21	324	176		1,61	370	200	
4	24,4	0,90	247	133		1,32	309	167		1,61	431	233		2,15	493	266	
5	31,2	1,13	296	159		1,65	371	199		2,01	518	278		2,69	592	318	
6	38,0	1,35	346	185		1,98	432	231		2,41	604	322		3,22	691	369	
7	44,8	1,58	403	210		2,31	504	263		2,81	705	368		3,76	806	421	
8	51,6	1,80	458	238		2,64	573	298		3,22	802	417		4,30	917	477	
9	58,4	2,03	513	266		2,97	641	333		3,62	899	466		4,83	1027	533	
10	65,2	2,25	572	299		3,30	714	373		4,02	1000	523		5,37	1143	597	
11	72,0	2,48	634	334		3,63	792	418		4,42	1109	585		5,91	1267	669	
12	78,8	2,70	695	371		3,96	869	463		4,82	1217	648		6,44	1391	741	

The prices found in the table refer to Anodized Silver Aluminium finish. For the Anodized BLACK, GREY TITANIUM and BRONZE version + 10%

Standard REAR CONNECTORS

They enable connection to the system via Remote Valve Assembly (GVR) which are supplied as an accessory. This type of connectors must be specified when placing the order, they are supplied WITHOUT an additional price charge

EXTERNAL CONNECTORS – standard type

They enable connection to the system via Standard Valve and Lockshield which are supplied as an accessory. This type of connectors must be specified when placing the order, they are supplied WITH an additional price charge of €

The center of the valve compared to the wall is 5 cm for SHV, for SHVD 14,4 cm

Standard connector

OR1

standard connector always supplied, if not otherwise specified in the order

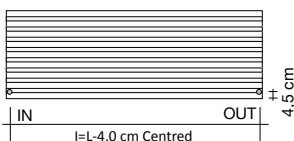

Aesthetic covering for SHO



connector OB2

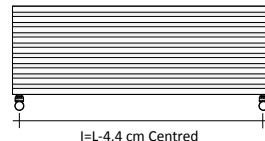

Connector on request RS2

Without additional price charge

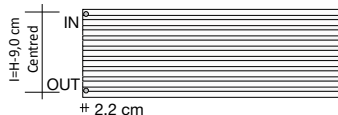

Connector on request RD2

Without additional price charge

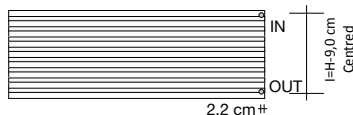

REMOTE VALVE ASSEMBLY

Valve and Lockshield assembly for remote connection (GVR), can be installed up to a maximum distance of 6 metres from the radiator.

Connection of Remote Valve Assembly (GVR) to water system

Code	Description	Finishes	Price (€)
GVR#	RECESSED valve and lockshield assembly for remote connection	CHROME	
GVRC#	RECESSED valve and lockshield assembly for remote connection	COLOUR	

For the GVRC code you must specify the colour required
 The external finish of the GVR is only Glossy Chrome-plated

SOHO FREE-STANDING VERTICAL DOUBLE

FREE-STANDING low water content radiator composed of double horizontal and vertical elements entirely made of aluminium



ORDER EXAMPLE To correctly order this model follow the example specified below:

PRODUCT SHVDF#180 005 9010 COP 9010
 SHVDF#180 005 Article code composed of Model, Height (200) and Number of elements (005)
 9010 Colour code to be checked in the Tubes Colour Chart
 COP9010 Standard covering code and relative finish to be checked in the Tubes Colour Chart

RECESSED PART(mandatory) INCSHVDF# Code for recessed part is the same for all the sizes

ACCESSORIES

Cod. GVR One way Remote Valve Assembly, CHROME finish

Cod. GVRC#* One way Remote Valve Assembly, COLOUR finish*

* Specify the color code, e.g.: 9010, after checking the Tubes Colour Chart

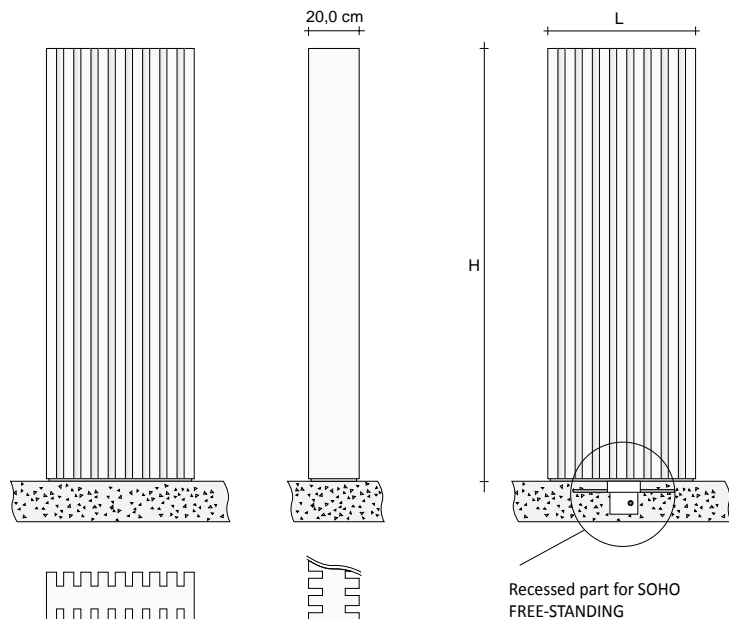

FLOOR RECESSED PART Cod. INCSHVDF

The recessed part can be ordered separately and it is strictly needed in order to install SOHO FREE-STANDING. This recessed part is connected to the heating system with GVR supplied

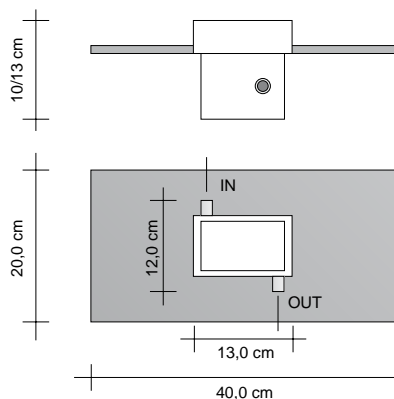

Connection of Soho recessed assembly to Remote Valve Assembly (GVR)

Height	60			80			100			140			160			180		
	N° elements	Width (cm)	Watts ΔT 50°C	Watts ΔT 30°C	Price (€)	Watts ΔT 50°C	Watts ΔT 30°C	Price (€)	Watts ΔT 50°C	Watts ΔT 30°C	Price (€)	Watts ΔT 50°C	Watts ΔT 30°C	Price (€)	Watts ΔT 50°C	Watts ΔT 30°C	Price (€)	
3	17,6	436	225		548	283		653	337		851	435		945	482		1036	529
4	24,4	582	301		730	377		871	449		1135	581		1260	642		1382	705
5	31,2	727	376		913	471		1089	561		1419	726		1575	803		1727	882
6	38,0	872	451		1096	566		1307	674		1703	871		1891	964		2073	1058
7	44,8	1018	526		1278	660		1525	786		1987	1017		2206	1125		2418	1234
8	51,6	1163	601		1461	754		1723	898									
9	58,4	1309	676		1644	848		1960	1010									
10	65,2	1454	751		1826	942		2178	1123									
11	72,0	1599	826		2009	1037												
12	78,8	1745	902		2191	1131												

RECESSED SOHO VERTICAL DOUBLE FREE-STANDING (recessed part)

Code	Description	Price (€)
INCSHVDF#	Recessed part SOHO vertical double	

ADDITIONAL CHARGES FOR COLOURS AND FINISHES (see the official Tubes Colour Chart)

Additional colour charges are calculated over the Pure white price (Cat. C0), for the other categories the additional charges herein below are applicable: C1 Category +10% - C2 and C3 Category +20% - RAL not included in the colour chart +30%. According to samples : Request feasibility and cost estimate. Colours not available: GRCC.

COVERINGS

Description	Ordered with the radiator		Ordered after the Radiator	
	Code	Price (€)	Code	Price (€)
Punched aesthetic covering with a different colour from the radiator	COP (col.fin*)		COPSHE#C	
Punched aesthetic covering with Galvanized finish (e.g.: Chrome, Gold...)	COP (col.fin*)		COPSHE#C	
CLOSED aesthetic covering with the same colour as the radiator	COP (col.fin*)	-	COPSHE#C	-
CLOSED aesthetic covering with a different colour from the radiator	COP (col.fin*)		COPSHE#C	
CLOSED aesthetic covering with Galvanized finish (e.g.: Chrome, Gold...)	COP (col.fin*)		COPSHE#C	

* Colour/finish means you have to indicate the code of colour or finish required

SOHO FREE-STANDING HORIZONTAL DOUBLE

FREE-STANDING low water content radiator composed of double horizontal and vertical elements entirely made of aluminium

ORDER EXAMPLE To correctly order this model follow the example specified below:

PRODUCT SHODF#180 005 9010 COP 9010
 SHODF#180 005 Article code composed of Model, Width (180) and Number of elements (005)
 9010 Colour code to be checked in the Tubes Colour Chart
 COP9010 Standard covering code and relative finish to be checked in the Tubes Colour Chart

ACCESSORIES

Cod. GVR One way Remote Valve Assembly, CHROME finish
 Cod. GVRC#* One way Remote Valve Assembly, COLOUR finish*
 * Specify the color code, e.g.: 9010, after checking the Tubes Colour Chart

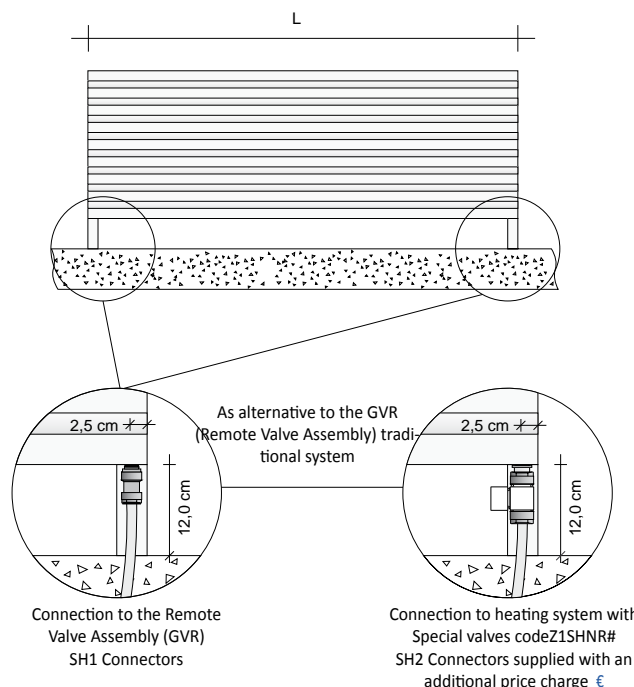
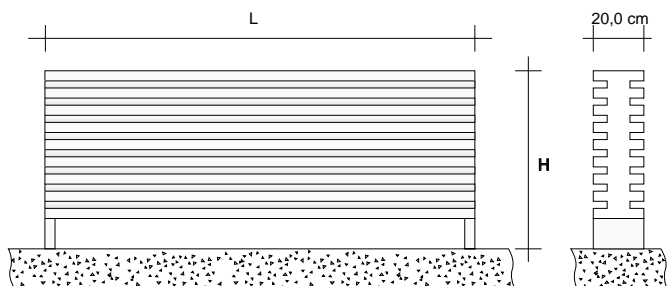

Width		100			140			160			180			200		
N° elements	Height (cm)	Watts ΔT 50°C	Watts ΔT 30°C	Price (€)	Watts ΔT 50°C	Watts ΔT 30°C	Price (€)	Watts ΔT 50°C	Watts ΔT 30°C	Price (€)	Watts ΔT 50°C	Watts ΔT 30°C	Price (€)	Watts ΔT 50°C	Watts ΔT 30°C	Price (€)
3	29,6	282	149		386	203		444	234		507	267		574	303	
4	36,4	376	199		515	271		592	312		676	356		766	404	
5	43,2	470	248		644	338		740	389		844	445		957	505	
6	50,0	564	298		773	406		888	467		1013	534		1148	606	
7	56,8	658	347		901	474		1037	546		1182	623		1340	707	

Width		220			240			280		
N° elements	Height (cm)	Watts ΔT 50°C	Watts ΔT 30°C	Price (€)	Watts ΔT 50°C	Watts ΔT 30°C	Price (€)	Watts ΔT 50°C	Watts ΔT 30°C	Price (€)
3	29,6	647	342		706	374		824	437	
4	36,4	863	456		941	498		1098	582	
5	43,2	1079	570		1177	623		1373	727	

Interaxis (Pipe centre) OF THE CONNECTORS = L - 5 cm.

Description	Ordered with the radiator		Ordered after the Radiator	
	Code	Price (€)	Code	Price (€)
CLOSED aesthetic covering with a different colour from the radiator	COP (COL.FIN*)		COPSHE#..COP....	
CLOSED aesthetic covering with Galvanized finish (e.g.: Chrome, Gold...)	COP (COL.FIN*)		COPSHEG#..COP....	

* Colour/finish means you have to indicate the code of colour or finish required

REMOTE VALVE ASSEMBLY

Valve and Lockshield assembly for remote connection (GVR), can be installed up to a maximum distance of 6 metres from the radiator.

Connection of Remote Valve Assembly (GVR) to water system

Code	Description	Finishes	Price (€)
GVR#	RECESSED valve and lockshield assembly for remote connection	CHROME	
GVRC#	RECESSED valve and lockshield assembly for remote connection	COLOUR	

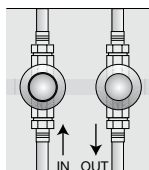

VALVES FOR SOHO FREE-STANDING HORIZONTAL DOUBLE (unions not included)
 Special straight valves and Lockshields for SOHO FREE-STANDING Horizontal double

Code	Description	Price (€)
Z1SHNR#	Valve for SOHO FREE-STANDING Horizontal Double	
Z1RAC#	Union for Z1SHNR Valve	