

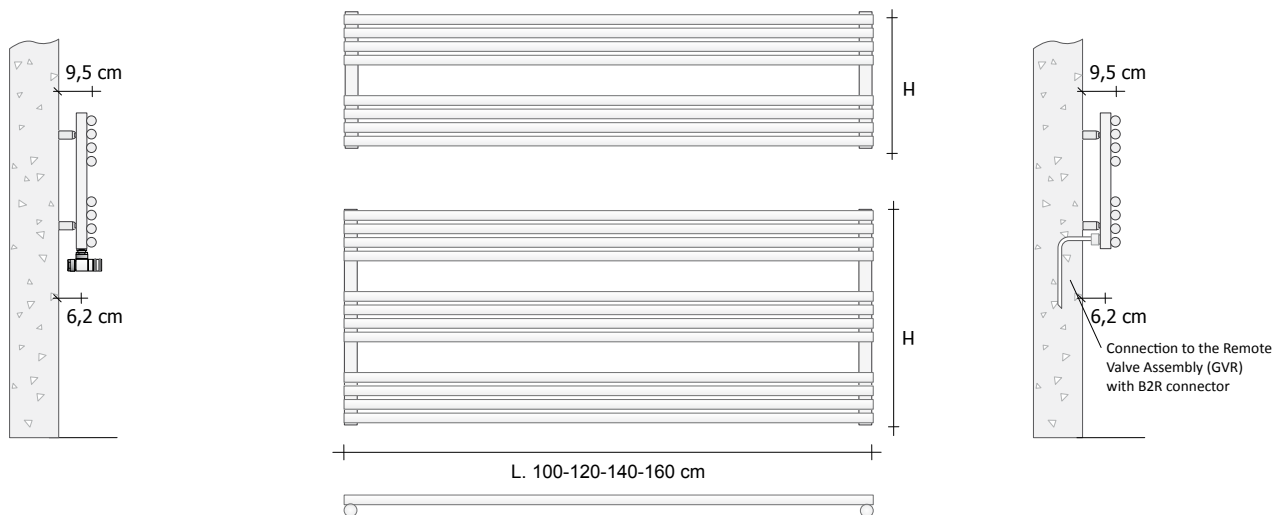

STANDARD HYDRAULIC VERSION  
(Connectors OB1)



REAR CONNECTORS VERSION  
(Connectors B2R)



**CONNECTORS** The heated towel rails are supplied as standard with connectors "OB1".

If different connectors are required, strictly indicate this in the order. **IMPORTANT:** the connectors for heated towel rails and radiators connected to the same system must all have the same configuration, otherwise operating problems may occur.

**Standard connectors**

Supplied unless otherwise specified in the order.

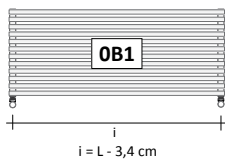

**Connectors on request**

Available upon request AT NO additional charge.

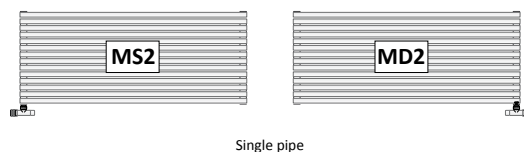

**Special connectors**

Provided upon request WITH an additional charge of

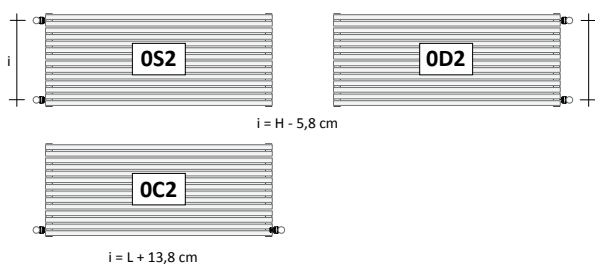

**Custom-made connectors**

Available upon request WITH an additional charge of

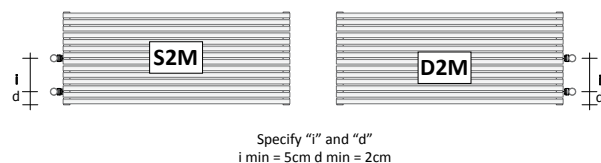

Product code **RO14S#100015OB1ST9010212**

- RO14S#100015 Article code specified in the price table
- OB1 Connector code see technical datasheet
- ST Standard support code\*
- 9010 Colour/finish code specified in the Official TUBES COLOUR CHART
- 212 Spacing code
- \* for special supports see BRACKET SUPPORTS page

**ADDITIONAL COLOUR CHARGES**

Finishes and Anodizing see page. 5 or the colour table provided at the end of this price list.

**RO14S#... standard hydraulic**

Model	H (cm)	L (cm)	Interaxis (cm)	Heat output in Watts				Price Standard White Cat. C0 (€)	Price Category C1/C2 (€)	Price Category Cat. C3 (€)	Price Chrome G0 (€)
				COLOURED version		CHROMED version					
				ΔT. 50°C	ΔT. 30°C	ΔT. 50°C	ΔT. 30°C				
RO14S#100015	37,0	100,0	96,6	397	207	366	191				
RO14S#100024	58,6	100,0	96,6	615	320	564	294				
RO14S#120015	37,0	120,0	116,6	476	248	438	228				
RO14S#120024	58,6	120,0	116,6	736	383	677	353				
RO14S#140015	37,0	140,0	136,6	556	290	511	266				
RO14S#140024	58,6	140,0	136,6	854	445	789	411				
RO14S#160015	37,0	160,0	156,6	635	331	584	304				
RO14S#160024	58,6	160,0	156,6	982	512	903	470				

In the Chrome (Plated) Version, code RO14S becomes RO14SG

**RO14S#... hydraulic with rear connectors B2R**

Model	H (cm)	L (cm)	Interaxis (cm)	Heat output in Watts				Price Standard White Cat. C0 (€)	Price Category C1/C2 (€)	Price Category Cat. C3 (€)	Price Chrome G0 (€)
				COLOURED version		CHROMED version					
				ΔT. 50°C	ΔT. 30°C	ΔT. 50°C	ΔT. 30°C				
RO14S#100015B2R	37,0	100,0	96,6	397	207	366	191				
RO14S#100024B2R	58,6	100,0	96,6	615	320	564	294				
RO14S#120015B2R	37,0	120,0	116,6	476	248	438	228				
RO14S#120024B2R	58,6	120,0	116,6	736	383	677	353				
RO14S#140015B2R	37,0	140,0	136,6	556	290	511	266				
RO14S#140024B2R	58,6	140,0	136,6	854	445	789	411				
RO14S#160015B2R	37,0	160,0	156,6	635	331	584	304				
RO14S#160024B2R	58,6	160,0	156,6	982	512	903	470				

In the Chrome (Plated) Version, code RO14S becomes RO14SG

**Standard convertible valves – Z1TLNR**

For more information on the choice of valves, see p. 310

	Code	Description	Finishes	Price (€)
	Z1TLNR#ANR12...	Paired Valve + Lockshield - Copper angle 1/2" and/or Multi-layer 1/2"	Standard White Colour C1/C2/C3	
	2 x Z1RAC#R12CRO	Paired 12 mm copper pipe unions	Glossy Chrome	
	ZRCF3#9010	Hole-covering washer kit for Heated towel rail	Standard White	

**Remote valve assembly – GVR**

For more information on the choice of valves, see p. 310

	Code	Description	Finishes	Price (€)
	GVR#1	RECESSED Valve that can be fitted with a thermostat and Lockshield assembly for REMOTE connection	Chromed Plated	
	GVRTG#1...	RECESSED thermostatic valve and Lockshield assembly for REMOTE connection*		
	GVR#1...	RECESSED Valve that can be fitted with a thermostat and Lockshield assembly for REMOTE connection	Coloured Coloured	
GVRTC#1...	RECESSED thermostatic valve and Lockshield assembly for REMOTE connection*			
Plated finishes: See table of Tubes special finishes Colored Finishes: see categories C0, C1, C2 and C3 of the Tubes color chart * The price does not include the cost of the thermostatic head (see page 320)				

# RITMATO 25 STANDARD - RO25S HYDRAULIC

Hydraulic Ritmato radiator made of carbon steel



STANDARD HYDRAULIC VERSION  
(Connectors OB1)



REAR CONNECTORS VERSION  
(Connectors B2R)

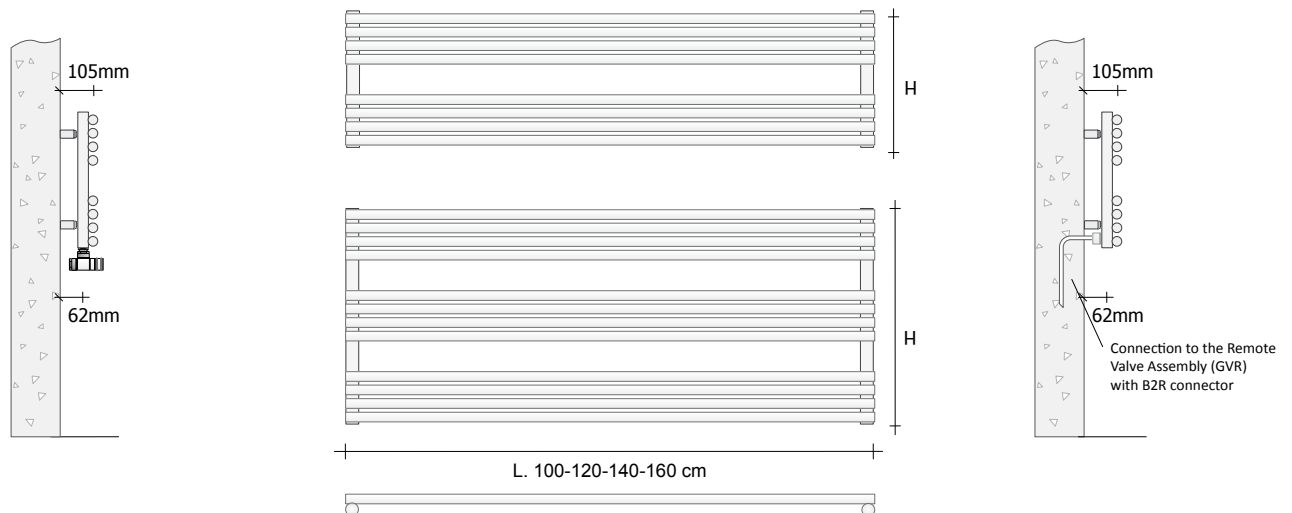

**CONNECTORS** The heated towel rails are supplied as standard with connectors "OB1"

If different connectors are required, strictly indicate this in the order. **IMPORTANT:** the connectors for heated towel rails and radiators connected to the same system must all have the same configuration, otherwise operating problems may occur.

**Standard connectors**

Supplied unless otherwise specified in the order.

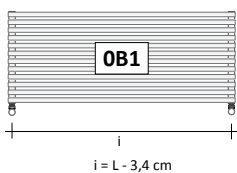

**Connectors on request**

Available upon request AT NO additional charge.

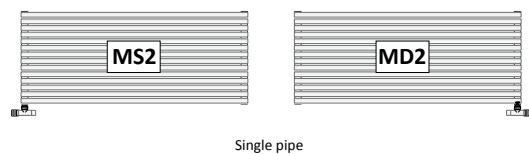

**Special connectors**

Provided upon request WITH an additional charge of

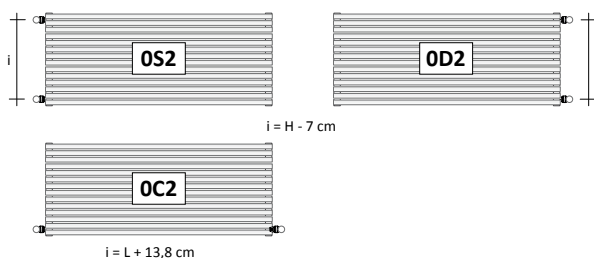

**Custom-made connectors**

Available upon request WITH an additional charge of

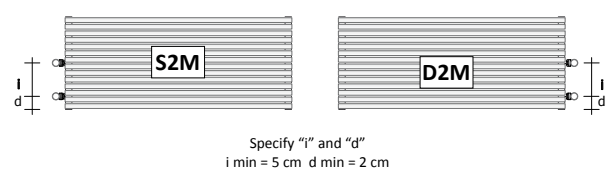

Product code **RO25S#1000100B1ST9010152**

- RO25S#100010 Article code specified in the price table
- OB1 Connector code see technical datasheet
- ST Standard support code\*
- 9010 Colour/finish code specified in the Official TUBES COLOUR CHART
- 152 Spacing code
- \* for special supports see BRACKET SUPPORTS page

**ADDITIONAL COLOUR CHARGES**

Finishes and Anodizing see page. 5 or the colour table provided at the end of this price list.

**RO25S#... standard hydraulic**

Model	H (cm)	L (cm)	Interaxis (cm)	Heat output in Watts COLOURED version		Price Standard White Cat. C0 (€)	Price Category C1/C2 (€)	Price Category Cat. C3 (€)
				ΔT. 50°C	ΔT. 30°C			
RO25S#100010	35,5	100,0	96,6	426	221			
RO25S#100016	56,5	100,0	96,6	642	333			
RO25S#120010	35,5	120,0	116,6	512	265			
RO25S#120016	56,5	120,0	116,6	771	399			
RO25S#140010	35,5	140,0	136,6	597	309			
RO25S#140016	56,5	140,0	136,6	899	466			
RO25S#160010	35,5	160,0	156,6	682	353			
RO25S#160016	56,5	160,0	156,6	1027	532			

Model	H (cm)	L (cm)	Interaxis (cm)	Heat output in Watts COLOURED version		Price Standard White Cat. C0 (€)	Price Category C1/C2 (€)	Price Category Cat. C3 (€)
				ΔT. 50°C	ΔT. 30°C			
RO25S#100010B2R	35,5	100,0	96,6	426	221			
RO25S#100016B2R	56,5	100,0	96,6	642	333			
RO25S#120010B2R	35,5	120,0	116,6	512	265			
RO25S#120016B2R	56,5	120,0	116,6	771	399			
RO25S#140010B2R	35,5	140,0	136,6	597	309			
RO25S#140016B2R	56,5	140,0	136,6	899	466			
RO25S#160010B2R	35,5	160,0	156,6	682	353			
RO25S#160016B2R	56,5	160,0	156,6	1027	532			

**Standard convertible valves – Z1TLNR**

For more information on the choice of valves, see p. 310

	Code	Description	Finishes	Price (€)
	Z1TLNR#ANR12...	Paired Valve + Lockshield - Copper angle 1/2" and/or Multi-layer 1/2"	Standard White Colour C1/C2/C3	
	Z1KITRAC#001	6-part connector KIT: - 2x Z1RAC#R12CRO - 2x Z1RAC#R14CRO - 2x Z1AC#M03CRO	Glossy Chrome	
	Z1KITRAC#002	8-part connector KIT: - 2x Z1RAC#R12CRO - 2x Z1RAC#R14CRO - 2x Z1RAC#M03CRO - 2x Z1RAC#M01CRO	Glossy Chrome	

**Remote valve assembly – GVR**

For more information on the choice of valves, see p. 310

	Code	Description	Finishes	Price (€)
	GVR#1	RECESSED Valve that can be fitted with a thermostat and Lockshield assembly for REMOTE connection	Chromed	
	GVRTG#1...	RECESSED thermostatic valve and Lockshield assembly for REMOTE connection*	Plated	
	GVR#1...	RECESSED Valve that can be fitted with a thermostat and Lockshield assembly for REMOTE connection	Coloured	
GVRTC#1...	RECESSED thermostatic valve and Lockshield assembly for REMOTE connection*	Coloured		
Plated finishes: See table of Tubes special finishes Colored Finishes: see categories C0, C1, C2 and C3 of the Tubes color chart * The price does not include the cost of the thermostatic head (see page 320)				

# RITMATO RO10S HYDRAULIC

Radiator comprising horizontal 10 mm diameter welded steel elements with 34 mm diameter manifolds



**STANDARD HYDRAULIC VERSION**  
(Connectors OB1)

**REAR CONNECTORS VERSION**  
(Connectors B2R)

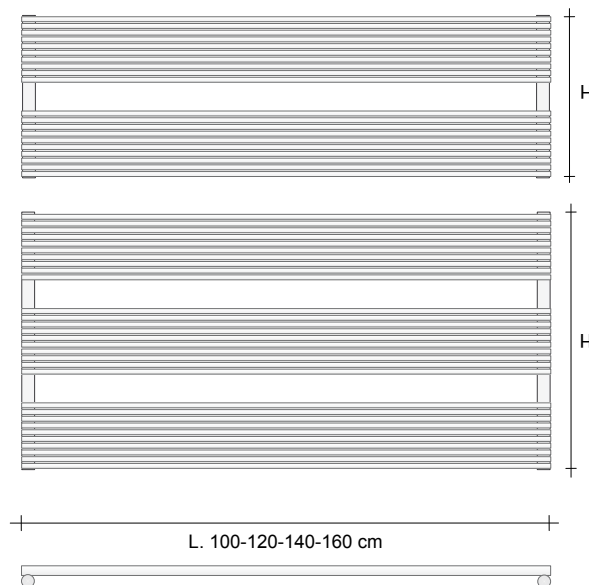
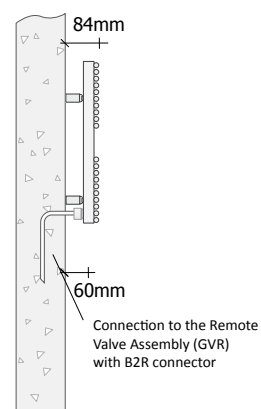
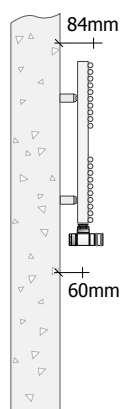

**CONNECTORS** The heated towel rails are supplied as standard with connectors "OB1"

If different connectors are required, strictly indicate this in the order. **IMPORTANT:** the connectors for heated towel rails and radiators connected to the same system must all have the same configuration, otherwise operating problems may occur.

**Standard connectors**

Supplied unless otherwise specified in the order.

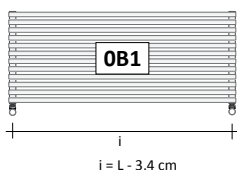

**Connectors on request**

Available upon request AT NO additional charge.

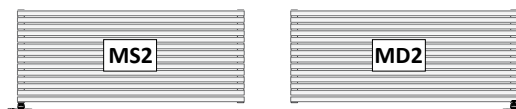

Single pipe

**Special connectors**

Provided upon request WITH an additional charge of

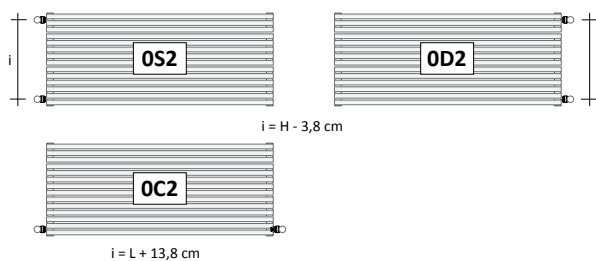

**Custom-made connectors**

Available upon request WITH an additional charge of

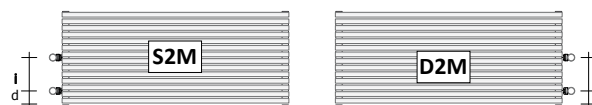

Specify "i" and "d"  
i min = 5 cm d min = 2 cm

**Code RO10S#100024 OB1 ST 9010 046**

RO10S#100024 Model Code, see price list.  
 OB1 Connector code, see type of connectors.  
 \* for special supports see BRACKET SUPPORTS page

**ADDITIONAL COLOUR CHARGES**

Finishes and Anodizing see page. 5 or the colour table provided at the end of this price list.

**RO10S#... standard hydraulic**

Model	H (cm)	L (cm)	Interaxis (cm)	Heat output in Watts				Price Standard White Cat. C0 (€)	Price Category C1/C2 (€)	Price Category Cat. C3 (€)	Price Chrome G0 (€)
				COLOURED version		CHROMED version					
				ΔT. 50°C	ΔT. 30°C	ΔT. 50°C	ΔT. 30°C				
RO10S#100024	36,9	100,0	96,6	517	277	413	221				
RO10S#100038	57,9	100,0	96,6	768	387	579	310				
RO10S#120024	36,9	120,0	116,6	620	405	615	324				
RO10S#120038	57,9	120,0	116,6	922	566	860	453				
RO10S#140024	36,9	140,0	136,6	723	332	496	266				
RO10S#140038	57,9	140,0	136,6	1075	443	661	354				
RO10S#160024	36,9	160,0	156,6	827	486	737	388				
RO10S#160038	57,9	160,0	156,6	1229	647	983	518				

**RO10S # ... hydraulic with B2R rear connectors**

Model	H (cm)	L (cm)	Interaxis (cm)	Heat output in Watts				Price Standard White Cat. C0 (€)	Price Category C1/C2 (€)	Price Category Cat. C3 (€)	Price Chrome G0 (€)
				COLOURED version		CHROMED version					
				ΔT. 50°C	ΔT. 30°C	ΔT. 50°C	ΔT. 30°C				
RO10S#100024B2R	36,9	100,0	96,6	517	277	413	221				
RO10S#100038B2R	57,9	100,0	96,6	768	387	579	310				
RO10S#120024B2R	36,9	120,0	116,6	620	405	615	324				
RO10S#120038B2R	57,9	120,0	116,6	922	566	860	453				
RO10S#140024B2R	36,9	140,0	136,6	723	332	496	266				
RO10S#140038B2R	57,9	140,0	136,6	1075	443	661	354				
RO10S#160024B2R	36,9	160,0	156,6	827	486	737	388				
RO10S#160038B2R	57,9	160,0	156,6	1229	647	983	518				

**Standard convertible valves – Z1TLNR**

For more information on the choice of valves, see p. 310

	Code	Description	Finishes	Price (€)
	Z1TLNR#ANR12...	Paired Valve + Lockshield - Copper angle 1/2" and/or Multi-layer 1/2"	Standard White Colour C1/C2/C3	
	Z1TLNRG#ANR12..	Paired Valve + Lockshield - Copper angle 1/2" and/or Multi-layer 1/2"	Glossy Chrome	
	Z1KITRAC#001	Union KIT with 6 pieces for Paired valves - 2 Z1RAC#R12CRO 12 mm copper system O-Rings - 2 Z1RAC#R14CRO 14 mm copper system O-Rings - 2 Z1AC#M03CRO Multi-layer 24x19x11.5/12-16x2/2.25 mm	Glossy Chrome	
	ZRCF3#9010	Couple pipe washer for Heated towel rail	Standard White	
	ZRCF3G#CRO	Couple pipe washer for Heated towel rail	Glossy Chrome	

**Remote valve assembly – GVR**

For more information on the choice of valves, see p. 310

	Code	Description	Finishes	Price (€)
	GVR#1	RECESSED Valve that can be fitted with a thermostat and Lockshield assembly for REMOTE connection	Chromed Plated	
	GVRTG#1...	RECESSED thermostatic valve and Lockshield assembly for REMOTE connection*	Coloured	
	GVR#1...	RECESSED Valve that can be fitted with a thermostat and Lockshield assembly for REMOTE connection	Coloured	
	GVRTC#1...	RECESSED thermostatic valve and Lockshield assembly for REMOTE connection*	Coloured	
Plated finishes: See table of Tubes special finishes Colored Finishes: see categories C0, C1, C2 and C3 of the Tubes color chart * The price does not include the cost of the thermostatic head (see page 320)				



**STANDARD HYDRAULIC VERSION**  
(Connectors 0B1)

**REAR CONNECTORS VERSION**  
(Connectors B2R)

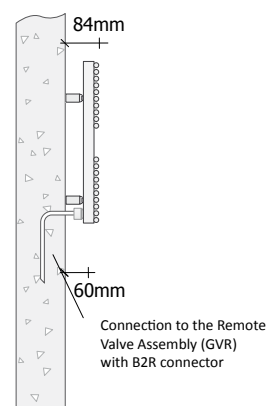
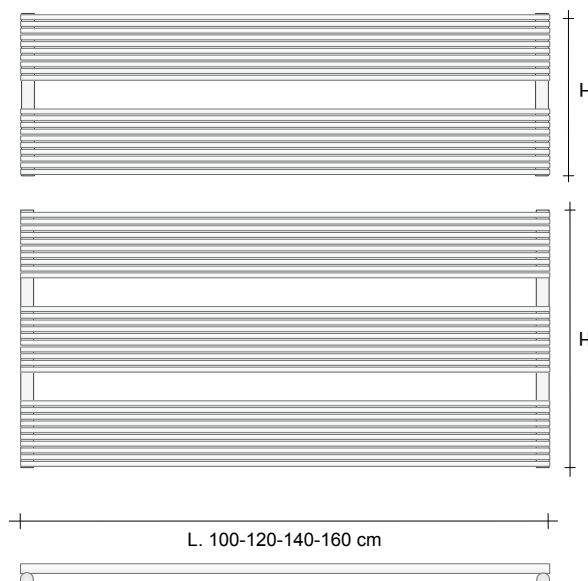
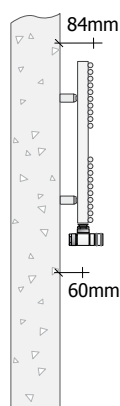

**CONNECTORS** The heated towel rails are supplied as standard with connectors "0B1".

If different connectors are required, strictly indicate this in the order. **IMPORTANT:** the connectors for heated towel rails and radiators connected to the same system must all have the same configuration, otherwise operating problems may occur.

**Standard connectors**

Supplied unless otherwise specified in the order.

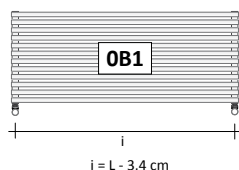

**Connectors on request**

Available upon request AT NO additional charge.

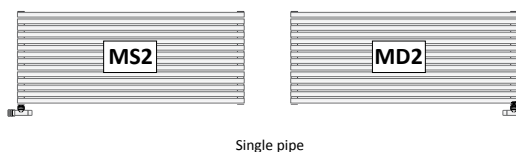

**Special connectors**

Provided upon request WITH an additional charge of

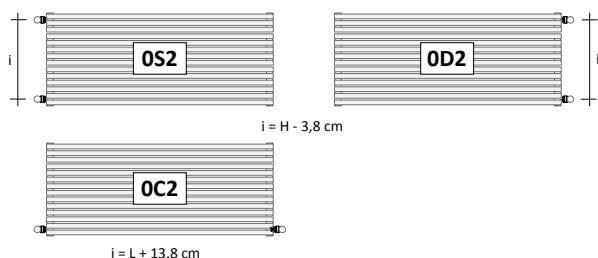

**Custom-made connectors**

Available upon request WITH an additional charge of

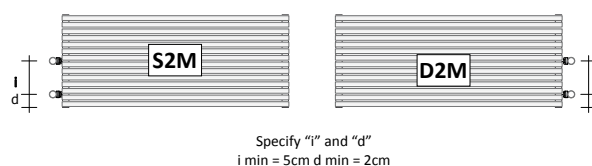

Product code **RXO10S#1000240B1STSPA006**

RXO10S#100024 Article code specified in the price table  
 OB1 Connector code see technical datasheet  
 ST Standard support code\*

**RXO10S#... standard hydraulic**

Model	H (cm)	L (cm)	Interaxis (cm)	Heat output in Watts Brushed stainless steel version		Price Inox(€)
				ΔT. 50°C	ΔT. 30°C	
RXO10S#100024	36,9	100,0	96,6	348	186	
RXO10S#100038	57,9	100,0	96,6	537	261	
RXO10S#120024	36,9	120,0	116,6	417	283	
RXO10S#120038	57,9	120,0	116,6	645	396	
RXO10S#140024	36,9	140,0	136,6	487	224	
RXO10S#140038	57,9	140,0	136,6	752	299	
RXO10S#160024	36,9	160,0	156,6	557	340	
RXO10S#160038	57,9	160,0	156,6	859	452	

**RXO10S#... hydraulic with rear connectors B2R**

Model	H (cm)	L (cm)	Interaxis (cm)	Heat output in Watts Brushed stainless steel version		Price Inox(€)
				ΔT. 50°C	ΔT. 30°C	
RXO10S#100024B2R	36,9	100,0	96,6	348	186	
RXO10S#100038B2R	57,9	100,0	96,6	537	261	
RXO10S#120024B2R	36,9	120,0	116,6	417	283	
RXO10S#120038B2R	57,9	120,0	116,6	645	396	
RXO10S#140024B2R	36,9	140,0	136,6	487	224	
RXO10S#140038B2R	57,9	140,0	136,6	752	299	
RXO10S#160024B2R	36,9	160,0	156,6	557	340	
RXO10S#160038B2R	57,9	160,0	156,6	859	452	

**Standard convertible valves - Z1TMNR -**

For more information on the choice of valves, see p. 310

	Code	Description	Finishes	Price (€)
	Z1TCXNR#ANR12...	Valve (that can be fitted with thermostat) and lockshield - STAINLESS STEEL COPPER ANGLE or MULTILAYER	Brushed Stainless Steel	
	Z1TMNR#ANR12SPA	Manual valve and lockshield - STAINLESS STEEL COPPER ANGLE or MULTILAYER	Brushed Stainless Steel	
	2 x Z1RACX#M03SPA	STAINLESS STEEL pipe unions for Multi-layer MM24x19x12 - 16x2	Brushed	

**Remote valve assembly – GVR**

For more information on the choice of valves, see p. 310

	Code	Description	Finishes	Price (€)
	GVRG#1...	RECESSED Valve that can be fitted with a thermostat and Lockshield assembly for REMOTE connection	Nickel Brushed	
	GVRTG#1...	Thermostatic valve* and lockshield assembly for recessed remote connection		
* The price does NOT include the cost of the thermostatic head (see page 320) *= Add the thermostatic control head from page xxx				





STANDARD HYDRAULIC VERSION  
(Connectors OB1)



STANDARD HYDRAULIC VERSION  
(Connectors B2R)

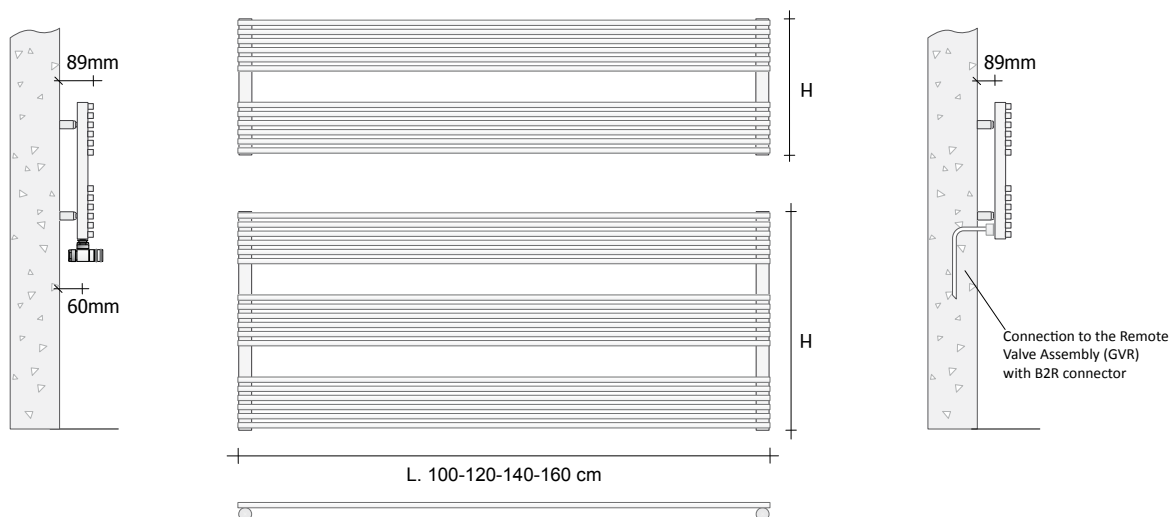

**CONNECTORS** The heated towel rails are supplied as standard with connectors "OB1"

If different connectors are required, strictly indicate this in the order. **IMPORTANT:** the connectors for heated towel rails and radiators connected to the same system must all have the same configuration, otherwise operating problems may occur.

**Standard connectors**

Supplied unless otherwise specified in the order.

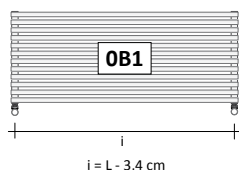

**Connectors on request**

Available upon request AT NO additional charge.

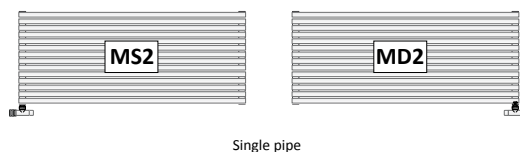

**Special connectors**

Provided upon request WITH an additional charge of

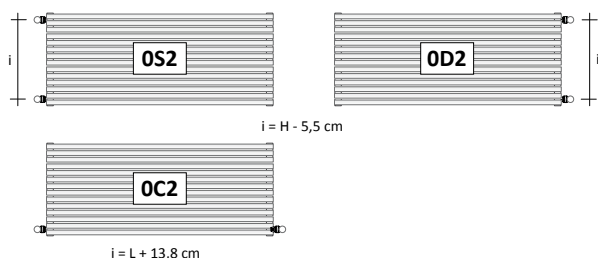

**Custom-made connectors**

Available upon request WITH an additional charge of

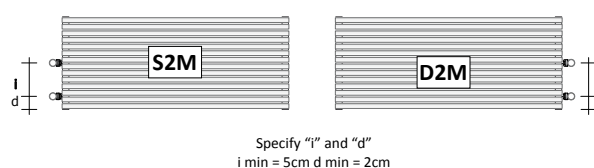

Product code **RKO15S#1000150B1ST9010212**

RKO15S#100015 Article code specified in the price table  
 OB1 Connector code see technical datasheet  
 ST Standard support code\*

**ADDITIONAL COLOUR CHARGES**

Finishes and Anodizing see page. 5 or the colour table provided at the end of this price list.

**RKO15S#... standard hydraulic**

Model	H (cm)	L (cm)	Interaxis (cm)	Heat output in Watts				Price Standard White Cat. C0 (€)	Price Category C1/C2 (€)	Price Category Cat. C3 (€)	Price Chrome G0 (€)
				COLOURED version		CHROMED version					
				ΔT. 50°C	ΔT. 30°C	ΔT. 50°C	ΔT. 30°C				
RKO15S#100015	37,9	100,0	96,6	502	266	452	239				
RKO15S#100024	60,4	100,0	96,6	754	400	679	360				
RKO15S#120015	37,9	120,0	116,6	603	319	543	288				
RKO15S#120024	60,4	120,0	116,6	904	479	814	432				
RKO15S#140015	37,9	140,0	136,6	703	372	633	335				
RKO15S#140024	60,4	140,0	136,6	1055	560	950	504				
RKO15S#160015	37,9	160,0	156,6	804	426	724	383				
RKO15S#160024	60,4	160,0	156,6	1206	640	1085	575				

In the Chrome (Plated) Version, code RKO15S becomes RKO15SG

**RKO15S#... hydraulic with rear connectors B2R**

Model	H (cm)	L (cm)	Interaxis (cm)	Heat output in Watts				Price Standard White Cat. C0 (€)	Price Category C1/C2 (€)	Price Category Cat. C3 (€)	Price Chrome G0 (€)
				COLOURED version		CHROMED version					
				ΔT. 50°C	ΔT. 30°C	ΔT. 50°C	ΔT. 30°C				
RKO15S#100015B2R	37,9	100,0	96,6	502	266	452	239				
RKO15S#100024B2R	60,4	100,0	96,6	754	400	679	360				
RKO15S#120015B2R	37,9	120,0	116,6	603	319	543	288				
RKO15S#120024B2R	60,4	120,0	116,6	904	479	814	432				
RKO15S#140015B2R	37,9	140,0	136,6	703	372	633	335				
RKO15S#140024B2R	60,4	140,0	136,6	1055	560	950	504				
RKO15S#160015B2R	37,9	160,0	156,6	804	426	724	383				
RKO15S#160024B2R	60,4	160,0	156,6	1206	640	1085	575				

In the Chrome (Plated) Version, code RKO15S becomes RKO15SG

**Standard convertible valves – Z1TLNR**

For more information on the choice of valves, see p. 310

	Code	Description	Finishes	Price (€)
	Z1TLNR#ANR12...	Paired Valve + Lockshield - Copper angle 1/2" and/or Multi-layer 1/2"	Standard White Colour C1/C2/C3	
	Z1KITRAC#001	6-part connector KIT: - 2x Z1RAC#R12CRO - 2x Z1RAC#R14CRO - 2x Z1AC#M03CRO	Glossy Chrome	
	Z1KITRAC#002	8-part connector KIT: - 2x Z1RAC#R12CRO - 2x Z1RAC#R14CRO - 2x Z1RAC#M03CRO - 2x Z1RAC#M01CRO	Glossy Chrome	

**Remote valve assembly – GVR**

For more information on the choice of valves, see p. 310

	Code	Description	Finishes	Price (€)
	GVR#1	RECESSED Valve that can be fitted with a thermostat and Lockshield assembly for REMOTE connection	Chromed Plated	
	GVRTG#1...	RECESSED thermostatic valve and Lockshield assembly for REMOTE connection*		
	GVRC#1...	RECESSED Valve that can be fitted with a thermostat and Lockshield assembly for REMOTE connection	Coloured Coloured	
GVRTC#1... RECESSED thermostatic valve and Lockshield assembly for REMOTE connection* Plated finishes: See table of Tubes special finishes Colored Finishes: see categories C0, C1, C2 and C3 of the Tubes color chart * The price does not include the cost of the thermostatic head (see page 320)				

# RITMATO CUSTOM MADE RO14 - RO14D

Hydraulic radiator made of carbon steel



CUSTOM-MADE Ritmato - RO14

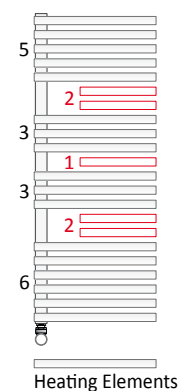

The CUSTOM-MADE RITMATO model has the distinguishing feature of having empty spaces as per the customer's requirements, so it is tailor-made; in order to understand how to place the correct order, please refer to detail "A" opposite.

RITMATO RO14 Width 180 cm  
Spacing 5-2-3-1-3-2-6

- In other words, from the top down:
- First group of 5 heating elements
  - Empty space 2 i.e. two fewer elements
  - First group of 3 heating elements
  - Empty space 1 i.e. one fewer element
  - First group of 3 heating elements
  - Empty space 2 i.e. two fewer elements

Heating Elements  
Empty space corresponding to a missing element

Based on the chosen spacing, the technical characteristics and the price are provided in the price table of the single CO14 model for the RO14 whereas for the double RO14D version, consult the data sheet for the CO14D. By checking the corresponding table, the result is:

Height  $5+2+3+1+3+2+5=21 = 53,8$  cm  
Heat output 1350 Wa DT50°C

# RITMATO CUSTOM MADE RO25 - RO25D

Hydraulic radiator made of carbon steel



CUSTOM-MADE Ritmato - RO25

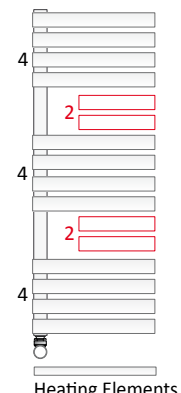
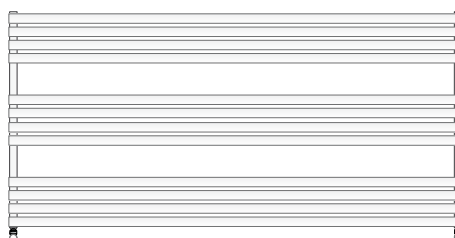

The CUSTOM-MADE RITMATO model has the distinguishing feature of having empty spaces as per the customer's requirements, so it is tailor-made; in order to understand how to place the correct order, please refer to detail "A" opposite. The spacing CANNOT be irregular but only constant.

RITMATO RO25 Width 150 cm  
Spacing 4-2-4-2-4 (constant spacing)

- In other words, from the top down:
- First group of 4 heating elements
  - Empty space 2 i.e. two fewer elements
  - First group of 4 heating elements
  - Empty space 2 i.e. two fewer elements
  - First group of 4 heating elements

Heating Elements  
Empty space corresponding to a missing element

Based on the chosen spacing, the technical characteristics and the price are provided in the price table of the single CO25 model for the RO25 whereas for the double RO25D version, consult the data sheet for the CO25D. By checking the corresponding table, the result is:

Height  $4+2+4+2+4=16$   
Heat output 1281 Wa DT50°C

CUSTOM-MADE Ritmato - RO14

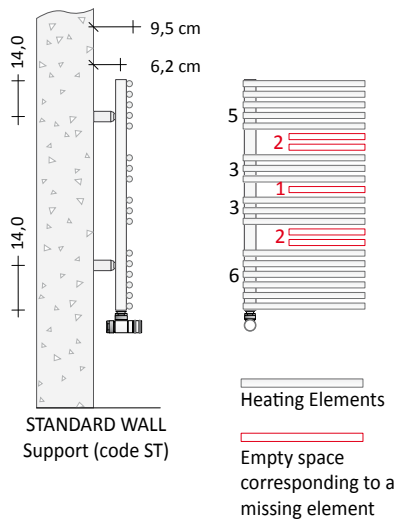

CUSTOM-MADE Ritmato - RO25

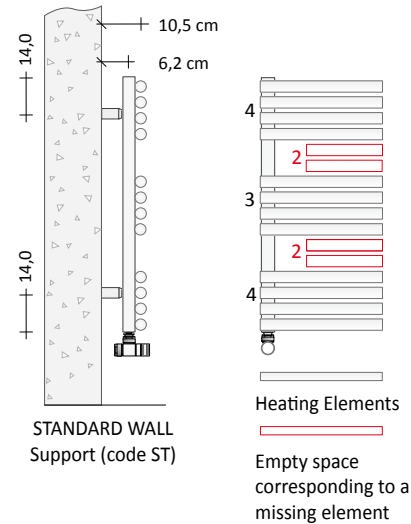

**CONNECTORS** The Horizontal Radiators are supplied as standard with connectors "OB1"

If different connectors are required, strictly indicate this in the order. **IMPORTANT:** the connectors for radiators connected to the same system must all have the same configuration, otherwise operating problems may occur.

**Standard connectors**

Supplied unless otherwise specified in the order.

**Special connectors**

Provided upon request **WITH** an additional charge of

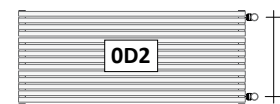
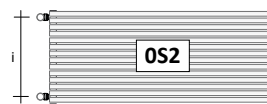
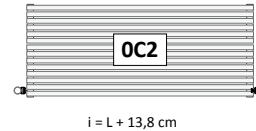
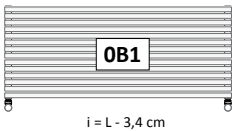

RO14/RO14D i = H - 5,8 cm  
RO25/RO25D i = H - 7,0 cm

**Connectors on request**

Connector available upon request **AT NO** additional charge.

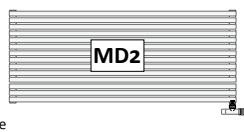
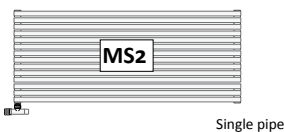

Single pipe

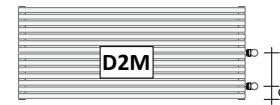
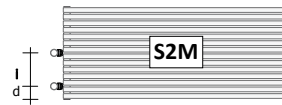

Specify "i" and "d"  
i min.= 5cm d min.=2cm

**Standard convertible valves – Z1TLNR**

For more information on the choice of valves, see p. 310

	Code	Description	Finishes	*Price (€)
	Z1TLNR#ANR12...	Paired Valve + Lockshield - Copper angle 1/2" and/or Multi-layer 1/2"	Standard White Colour C1/C2/C3	
	Z1KITRAC#001	6-part connector KIT: - 2x Z1RAC#R12CRO - 2x Z1RAC#R14CRO - 2x Z1AC#M03CRO	Glossy Chrome	
	Z1KITRAC#002	8-part connector KIT: - 2x Z1RAC#R12CRO - 2x Z1RAC#R14CRO - 2x Z1RAC#M03CRO - 2x Z1RAC#M01CRO	Glossy Chrome	

For versions with a Coloured finish other than white, see pages 314, 315, 316, 317, 318.



**Ritmato KUBIK electric - RKO15SE..**

All the thermostats referred to in the following articles comply with the ECodesign standard.

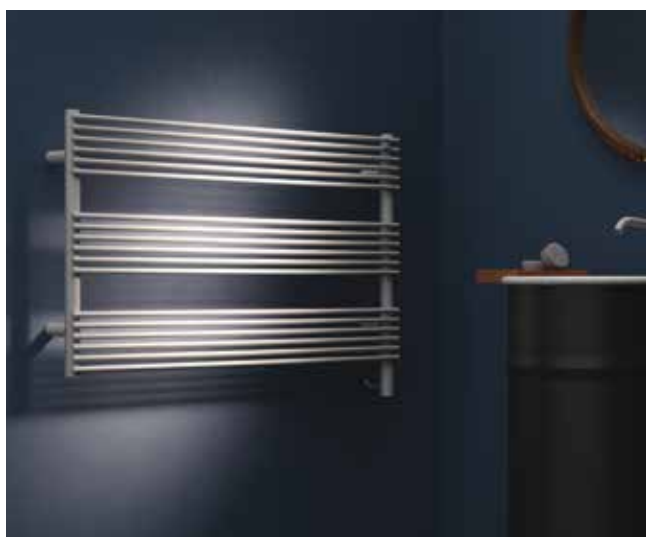
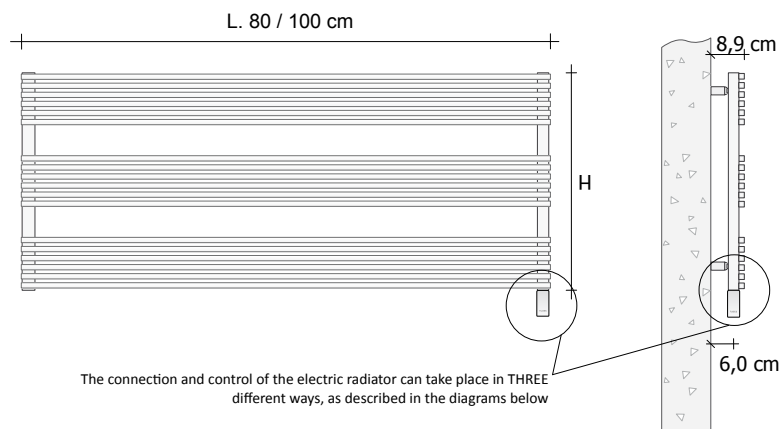

**Ritmato 14 electric - RKO15SE..**

All the thermostats referred to in the following articles comply with the ECodesign standard.

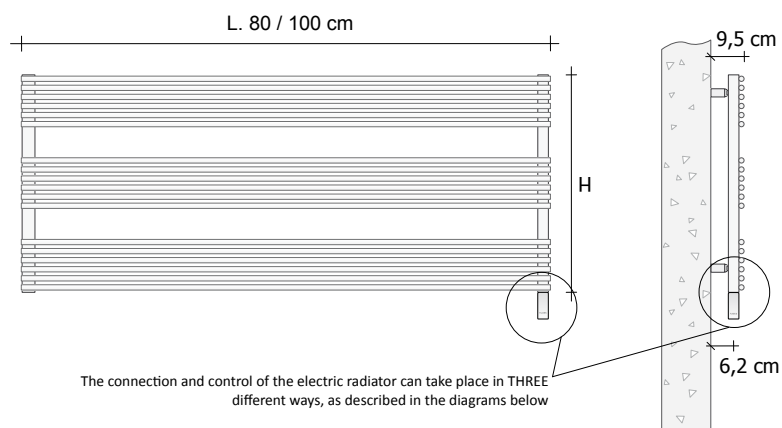

**Ritmato 25 electric - RKO15SE..**

All the thermostats referred to in the following articles comply with the ECodesign standard.

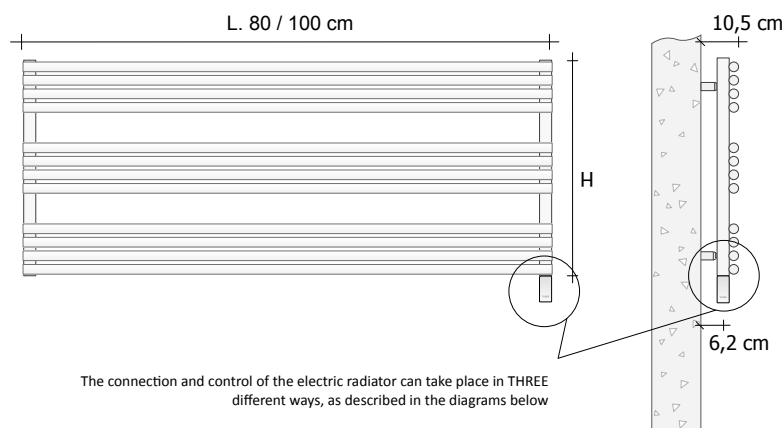

**Method of connection and control of the electric radiator**

Connection to the electricity mains with Standard Edge Cap

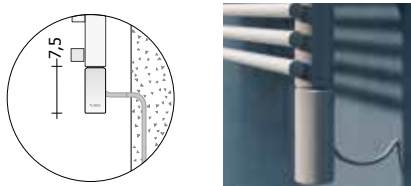

Connection to the electricity mains with ECodesign Thermostat

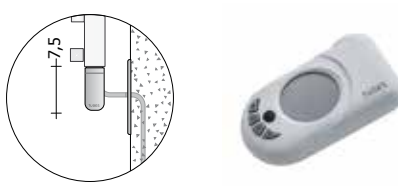

Connection to the electricity mains with ECodesign Wireless Thermostat

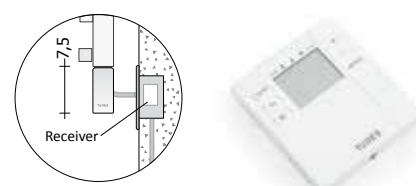

All the thermostats referred to in the following articles comply with the ECodesign standard.

**ADDITIONAL COLOUR CHARGES**

Finishes and Anodizing see page. 5 or the colour table provided at the end of this price list.

**RITMATO KUBIK electric - RKO15SE.. -**

The electric version with WIRELESS control includes the digital Chronothermostat Kit

Electric version with edge cap	Colour code of the edge cap			Code DESIGN* Edge Cap*	L (cm)	H (cm)	Electrical Resistance (Watts)	Price Standard White Cat. C0 (€)	Price Category C1/C2 (€)	Price Category Cat. C3 (€)	Price Chrome G0 (€)
	White	Anthracite Grey	Chrome*								
RKO15SEL#080024	U6	V6	Z6	T7	80,0	60,4	400 W				
RKO15SEL#100024	U2	V2	Z2	T8	100,0	60,4	600 W				
Electric version with ECOdesign thermostat	Thermostat code ROOM*			Code DESIGN* Edge Cap*	L (cm)	H (cm)	Electrical Resistance (Watts)	Price Standard White Cat. C0 (€)	Price Category C1/C2 (€)	Price Category Cat. C3 (€)	Price Chrome G0 (€)
	White	Chrome	Matt Black								
RKO15SET#080024	J6	J8	JP	JP	80,0	60,4	400 W				
RKO15SET#100024	G5	G7	JQ	JQ	100,0	60,4	600 W				
Electric version with wireless ECOdesign controls	Colour code of the edge cap			Code DESIGN* Edge Cap*	L (cm)	H (cm)	Electrical Resistance (Watts)	Price Standard White Cat. C0 (€)	Price Category C1/C2 (€)	Price Category Cat. C3 (€)	Price Chrome G0 (€)
	White	Anthracite Grey	Chrome								
RKO15SEW#080024	U6	V6	Z6	T7	80,0	60,4	400 W				
RKO15SEW#100024	U2	V2	Z2	T8	100,0	60,4	600 W				

**RITMATO 14 electric - RO14SE.. -**

The electric version with WIRELESS control includes the digital Chronothermostat Kit

Electric version with edge cap	Colour code of the edge cap			Code DESIGN* Edge Cap*	L (cm)	H (cm)	Electrical Resistance (Watts)	Price Standard White Cat. C0 (€)	Price Category C1/C2 (€)	Price Category Cat. C3 (€)	Price Chrome G0 (€)
	White	Anthracite Grey	Chrome*								
RO14SEL#080024	U6	V6	Z6	T7	80,0	58,6	400 W				
RO14SEL#100024	U2	V2	Z2	T8	100,0	58,6	600 W				
Electric version with ECOdesign thermostat	Thermostat code ROOM*			Code DESIGN* Edge Cap*	L (cm)	H (cm)	Electrical Resistance (Watts)	Price Standard White Cat. C0 (€)	Price Category C1/C2 (€)	Price Category Cat. C3 (€)	Price Chrome G0 (€)
	White	Chrome	Matt Black								
RO14SET#080024	J6	J8	JP	JP	80,0	58,6	400 W				
RO14SET#100024	G5	G7	JQ	JQ	100,0	58,6	600 W				
Electric version with wireless ECOdesign controls	Colour code of the edge cap			Code DESIGN* Edge Cap*	L (cm)	H (cm)	Electrical Resistance (Watts)	Price Standard White Cat. C0 (€)	Price Category C1/C2 (€)	Price Category Cat. C3 (€)	Price Chrome G0 (€)
	White	Anthracite Grey	Chrome								
RO14SEW#080024	U6	V6	Z6	T7	80,0	58,6	400 W				
RO14SEW#100024	U2	V2	Z2	T8	100,0	58,6	600 W				

**RITMATO 25 electric - RO25SE.. -**

The electric version with WIRELESS control includes the digital Chronothermostat Kit

Electric version with edge cap	Colour code of the edge cap			Code DESIGN* Edge Cap*	L (cm)	H (cm)	Electrical Resistance (Watts)	Price Standard White Cat. C0 (€)	Price Category C1/C2 (€)	Price Category Cat. C3 (€)	Price Chrome G0 (€)
	White	Anthracite Grey	Chrome*								
RO25SEL#080016	U6	V6	Z6	T7	80,0	56,5	400 W				
RO25SEL#100016	U2	V2	Z2	T8	100,0	56,5	600 W				
Electric version with ECOdesign thermostat	Thermostat code ROOM*			Code DESIGN* Edge Cap*	L (cm)	H (cm)	Electrical Resistance (Watts)	Price Standard White Cat. C0 (€)	Price Category C1/C2 (€)	Price Category Cat. C3 (€)	Price Chrome G0 (€)
	White	Chrome	Matt Black								
RO25SET#080016	J6	J8	JP	JP	80,0	56,5	400 W				
RO25SET#100016	G5	G7	JQ	JQ	100,0	56,5	600 W				
Electric version with wireless ECOdesign controls	Colour code of the edge cap			Code DESIGN* Edge Cap*	L (cm)	H (cm)	Electrical Resistance (Watts)	Price Standard White Cat. C0 (€)	Price Category C1/C2 (€)	Price Category Cat. C3 (€)	Price Chrome G0 (€)
	White	Anthracite Grey	Chrome								
RO25SEW#080016	U6	V6	Z6	T7	80,0	56,5	400 W				
RO25SEW#100016	U2	V2	Z2	T8	100,0	56,5	600 W				

\* Provided with an additional charge of

\*\* The DESIGN edge cap, painted in the same color as the towel warmer ordered, is supplied with a price supplement of for both the C1 / C2 / C3 and Chrome version.

Technical note:

Some elements in the lower and upper part of the electric versions of the RITMATO model warm up while working, but do not really heat up.