

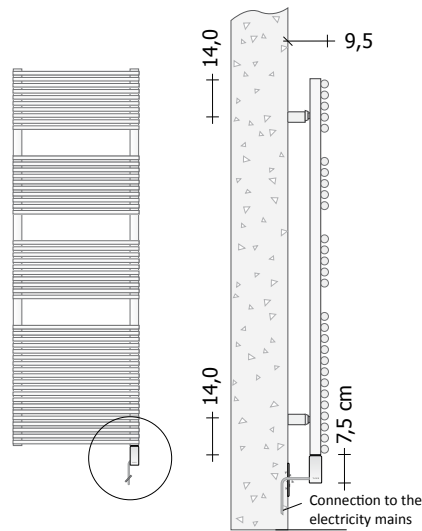

ELECTRIC VERSION WITH EDGE CAP

(Only available for the non EEC market and/or connected to a home automation system with characteristics complying with ECODesign regulations)



Connection to the electricity mains with Standard Edge Cap

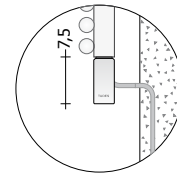

Connection to the electricity mains with DESIGN edge cap painted in the same colour (supplied with an extra charge)

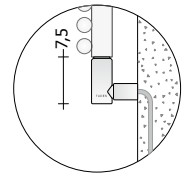

ELECTRIC VERSION WITH ECODesign THERMOSTAT

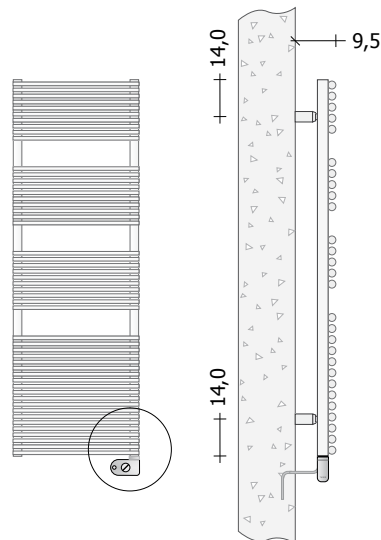

Connection to the electricity mains

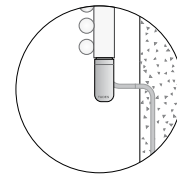

ECODesign Room Thermostat

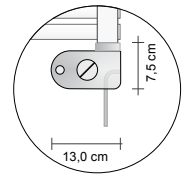

ELECTRIC VERSION WITH WIRELESS ECODesign CONTROLS

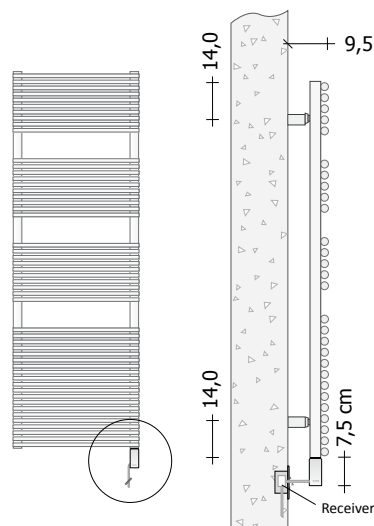

Wireless connection with Standard Edge Cap

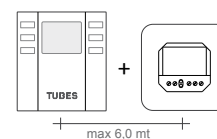
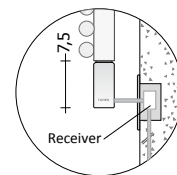

ECODesign digital wireless chronothermostat + Receiver

Wireless connection with DESIGN edge cap painted in the same colour (supplied with an extra charge)

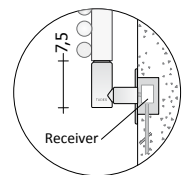

Digital Chronothermostat (code ZRF007)

Product code BA14EL#120050U2ST9010

ADDITIONAL COLOUR CHARGES

BA14EL#120050 Article code specified in the price table
 U2 Heating element code
 ST Standard support code*
 9010 Colour/finish code specified in the Official TUBES COLOUR CHART

Finishes and Anodizing see page. 5 or the colour table provided at the end of this price list.

* Special supports NOT available

ELECTRIC VERSION WITH EDGE CAP

Only available for the extra EEC market and/or connected to a home automation system complying with ECODesign regulations

Model	Colour code of the edge cap			Code DESIGN* Edge Cap	H (cm)	L (cm)	Electrical Resistance (Watts)	Price Standard White Cat. C0 (€)	Price Category C1/C2 (€)	Price Category Cat. C3 (€)	Price Chrome G0 (€)
	White	Anthracite Grey	Chrome								
BA14EL#080040	U1	V1	Z1	T6	82,6	40,0	300 W				
BA14EL#080050	U1	V1	Z1	T6	82,6	50,0	300 W				
BA14EL#080060	U2	V2	Z2	T8	82,6	60,0	600 W				
BA14EL#120040	U2	V2	Z2	T8	116,2	40,0	600 W				
BA14EL#120050	U2	V2	Z2	T8	116,2	50,0	600 W				
BA14EL#120060	U3	V3	Z3	T9	116,2	60,0	900 W				
BA14EL#150040	U2	V2	Z2	T8	149,8	40,0	600 W				
BA14EL#150050	U3	V3	Z3	T9	149,8	50,0	900 W				
BA14EL#150060	U3	V3	Z3	T9	149,8	60,0	900 W				
BA14EL#190040	U3	V3	Z3	T9	195,4	40,0	900 W				
BA14EL#190050	U3	V3	Z3	T9	195,4	50,0	900 W				
BA14EL#190060	U4	V4	Z4	T0	195,4	60,0	1200 W				

* The DESIGN EDGE CAP is produced in painted metal in the same Colour/Finish as the towel rail and it does not expose the heating element connection cable, this end piece is supplied upon request with an additional charge of

ELECTRIC VERSION WITH ECODesign ROOM THERMOSTAT

Model	Thermostat code					H (cm)	L (cm)	Electrical Resistance (Watts)	Price Standard White Cat. C0 (€)	Price Category C1/C2 (€)	Price Category Cat. C3 (€)	Price Chrome G0 (€)
	White	ROOM* Chrome	Matt Black	RADIATOR**								
BA14ET#080040	F5	F7	JO	N1	N5	82,6	40,0	300 W				
BA14ET#080050	F5	F7	JO	N1	N5	82,6	50,0	300 W				
BA14ET#080060	G5	G7	JQ	N2	N6	82,6	60,0	600 W				
BA14ET#120040	G5	G7	JQ	N2	N6	116,2	40,0	600 W				
BA14ET#120050	G5	G7	JQ	N2	N6	116,2	50,0	600 W				
BA14ET#120060	H5	H7	JR	N3	N7	116,2	60,0	900 W				
BA14ET#150040	G5	G7	JQ	N2	N6	149,8	40,0	600 W				
BA14ET#150050	H5	H7	JR	N3	N7	149,8	50,0	900 W				
BA14ET#150060	H5	H7	JR	N3	N7	149,8	60,0	900 W				
BA14ET#190040	H5	H7	JR	N3	N7	195,4	40,0	900 W				
BA14ET#190050	H5	H7	JR	N3	N7	195,4	50,0	900 W				
BA14ET#190060	I5	I7	JS	N4	N8	195,4	60,0	1200 W				

* In addition to the White finish, the ROOM thermostat is available in the CHROME finish and in the new MATT BLACK finish with an extra charge of

** The RADIATOR thermostat is not ECODesign

ELECTRIC VERSION WITH WIRELESS ECODesign CONTROLS

The electric version with WIRELESS control includes the digital Chronothermostat Kit

Model	Colour code of the edge cap			Code DESIGN* Edge Cap	Adjustment code WIRELESS THERMOSTAT	H (cm)	L (cm)	Electrical Resistance (Watts)	Price Standard White Cat. C0 (€)	Price Category C1/C2 (€)	Price Category Cat. C3 (€)	Price Chrome G0 (€)
	White	Anthracite Grey	Chrome									
BA14EW#080040	U1	V1	Z1	T6	ZRF007	82,6	40,0	300 W				
BA14EW#080050	U1	V1	Z1	T6	ZRF007	82,6	50,0	300 W				
BA14EW#080060	U2	V2	Z2	T8	ZRF007	82,6	60,0	600 W				
BA14EW#120040	U2	V2	Z2	T8	ZRF007	116,2	40,0	600 W				
BA14EW#120050	U2	V2	Z2	T8	ZRF007	116,2	50,0	600 W				
BA14EW#120060	U3	V3	Z3	T9	ZRF007	116,2	60,0	900 W				
BA14EW#150040	U2	V2	Z2	T8	ZRF007	149,8	40,0	600 W				
BA14EW#150050	U3	V3	Z3	T9	ZRF007	149,8	50,0	900 W				
BA14EW#150060	U3	V3	Z3	T9	ZRF007	149,8	60,0	900 W				
BA14EW#190040	U3	V3	Z3	T9	ZRF007	195,4	40,0	900 W				
BA14EW#190050	U3	V3	Z3	T9	ZRF007	195,4	50,0	900 W				
BA14EW#190060	U4	V4	Z4	T0	ZRF007	195,4	60,0	1200 W				

* The DESIGN EDGE CAP is produced in painted metal in the same Colour/Finish as the towel rail and it does not expose the heating element connection cable, this end piece is supplied upon request with an additional charge of

CONNECTORS The heated towel rails are supplied as standard with connectors "OB1"

If different connectors are required, strictly indicate this in the order. **IMPORTANT:** the connectors for heated towel rails and radiators connected to the same system must all have the same configuration, otherwise operating problems may occur.

Special connectors

Provided upon request WITH an additional charge of

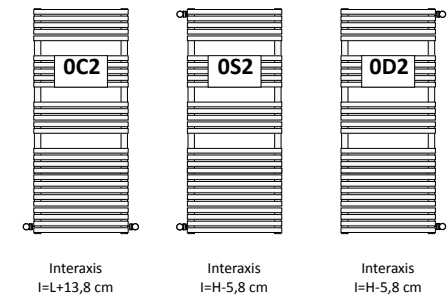

Connectors on request

Available upon request AT NO additional charge.

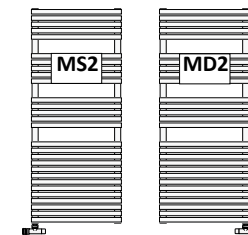

Single pipe

Custom-made connectors

Available upon request WITH an additional charge of

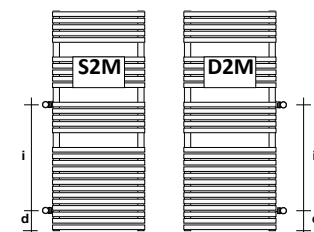

Specify "i" and "d"
i min = 5cm d min = 2cm



STANDARD HYDRAULIC VERSION
(Connectors OB1)

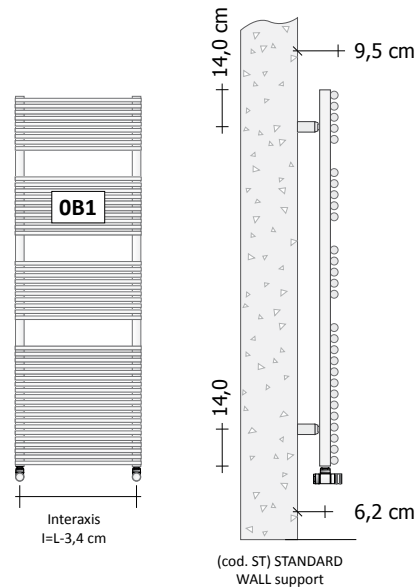

STANDARD HYDRAULIC VERSION
(Connectors B2R)

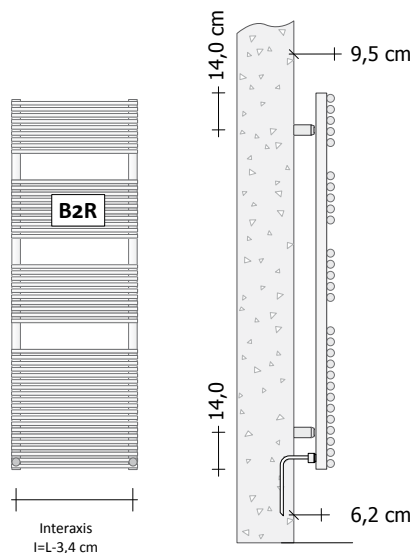

Standard convertible valves – Z1TLNR

For more information on the choice of valves, see p. 310



Code	Description	Finishes	Price (€)
Z1TLNR#ANR12...	Paired Valve + Lockshield - Copper angle 1/2" and/or Multi-layer 1/2"	Standard White Colour C1/C2/C3	
Z1TLNRG#ANR12..	Paired Valve + Lockshield - Copper angle 1/2" and/or Multi-layer 1/2"	Glossy Chrome	
Z1KITRAC#001	Union KIT with 6 pieces for Paired valves - 2 Z1RAC#R12CRO 12 mm copper system O-Rings - 2 Z1RAC#R14CRO 14 mm copper system O-Rings - 2 Z1AC#M03CRO Multi-layer 24x19x11.5/12-16x2/2.25 mm	Glossy Chrome	
ZRCF3#9010	Couple pipe washer for Heated towel rail	Standard White	
ZRCF3G#CRO	Couple pipe washer for Heated towel rail	Glossy Chrome	

Product code BA14#1200500B1ST9010

- BA14#120050 Article code specified in the price table
 - OB1 Connector code see technical datasheet
 - ST Standard support code*
 - 9010 Colour/finish code specified in the Official TUBES COLOUR CHART
- * for special supports see BRACKET SUPPORTS page

ADDITIONAL COLOUR CHARGES

Finishes and Anodizing see page. 5 or the colour table provided at the end of this price list.

IN STOCK

available in stock with connectors OB1, Standard White and/or Chrome colours.
Maximum quantity for item: 5 pcs

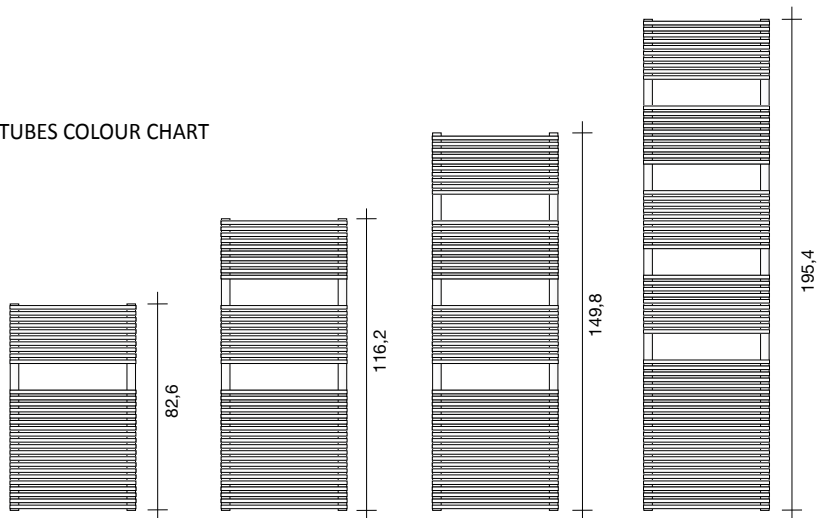

BA14#... Hydraulic

Model	H (cm)	L (cm)	Interaxis (cm)	Heat output in Watts				Price Standard White Cat. C0 (€)	Price Category C1/C2 (€)	Price Category Cat. C3 (€)	Price Chrome G0 (€)
				COLOURED version ΔT. 50°C	COLOURED version ΔT. 30°C	CHROMED version ΔT. 50°C	CHROMED version ΔT. 30°C				
BA14#080040	82,6	40,0	36,6	367	204	271	142	IN STOCK		IN STOCK	
BA14#080050	82,6	50,0	46,6	459	255	345	182				
BA14#080060	82,6	60,0	56,6	550	306	418	222				
BA14#120040	116,2	40,0	36,6	488	270	386	204				
BA14#120050	116,2	50,0	46,6	610	338	471	250				
BA14#120060	116,2	60,0	56,6	732	405	556	297				
BA14#150040	149,8	40,0	36,6	598	331	481	249				
BA14#150050	149,8	50,0	46,6	747	413	585	306				
BA14#150060	149,8	60,0	56,6	896	496	689	363				
BA14#190040	195,4	40,0	36,6	781	429	625	323				
BA14#190050	195,4	50,0	46,6	977	536	758	394				
BA14#190060	195,4	60,0	56,6	1172	643	891	465				

In the Chrome (Plated) Version, code BA14 becomes BA14G

BA14#...hydraulic with rear connectors B2R

Model	H (cm)	L (cm)	Interaxis (cm)	Heat output in Watts				Price Standard White Cat. C0 (€)	Price Category C1/C2 (€)	Price Category Cat. C3 (€)	Price Chrome G0 (€)
				COLOURED version ΔT. 50°C	COLOURED version ΔT. 30°C	CHROMED version ΔT. 50°C	CHROMED version ΔT. 30°C				
BA14#080040B2R	82,6	40,0	36,6	367	204	271	142				
BA14#080050B2R	82,6	50,0	46,6	459	255	345	182				
BA14#080060B2R	82,6	60,0	56,6	550	306	418	222				
BA14#120040B2R	116,2	40,0	36,6	488	270	386	204				
BA14#120050B2R	116,2	50,0	46,6	610	338	471	250				
BA14#120060B2R	116,2	60,0	56,6	732	405	556	297				
BA14#150040B2R	149,8	40,0	36,6	598	331	481	249				
BA14#150050B2R	149,8	50,0	46,6	747	413	585	306				
BA14#150060B2R	149,8	60,0	56,6	896	496	689	363				
BA14#190040B2R	195,4	40,0	36,6	781	429	625	323				
BA14#190050B2R	195,4	50,0	46,6	977	536	758	394				
BA14#190060B2R	195,4	60,0	56,6	1172	643	891	465				

In the Chrome (Plated) Version, code BA14 becomes BA14G

Remote valve assembly – GVR

For more information on the choice of valves, see p. 310

Code	Description	Finishes	Price (€)
GVR#1... GVRTC#1...	RECESSED Valve that can be fitted with a thermostat and Lockshield assembly for REMOTE connection RECESSED thermostatic valve and Lockshield assembly for REMOTE connection*	Coloured Coloured	

Plated finishes: See table of Tubes special finishes
Colored Finishes: see categories C0, C1, C2 and C3 of the Tubes color chart
* The price does not include the cost of the thermostatic head (see page 320)

SIZES AVAILABLE TO ORDER:

All the sizes in WIDTH every 10 cm starting from 70 cm up to 100 cm can be PROVIDED ON DEMAND and the price is calculated upon request.

IN THE PACK

The heated towel rails are supplied with their respective standard supports (code ST), that include the wall fixing shelves, pressure anchors and the respective vent valve, all included inside the pack and included in the price.

BATH 14 DOUBLE - BA14D HYDRAULIC

Hydraulic heated towel rail made of carbon steel



STANDARD HYDRAULIC VERSION (Connectors OB1)

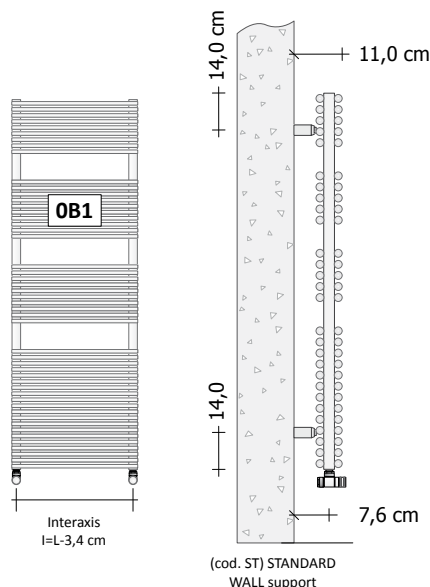

CONNECTORS The heated towel rails are supplied as standard with connectors "OB1"

If different connectors are required, strictly indicate this in the order. **IMPORTANT:** the connectors for heated towel rails and radiators connected to the same system must all have the same configuration, otherwise operating problems may occur.

Special connectors

Provided upon request WITH an additional charge of

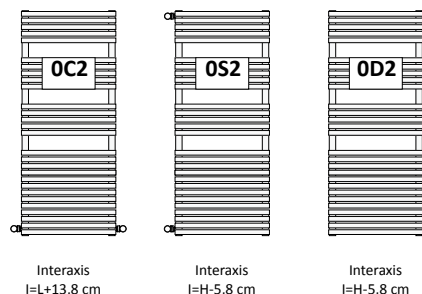

Connectors on request

Available upon request AT NO additional charge.

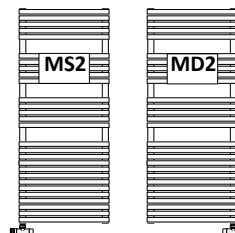

Single pipe

Custom-made connectors

Available upon request WITH an additional charge of

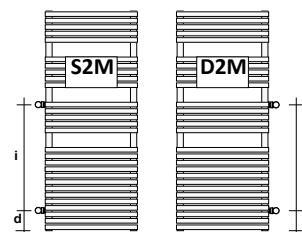

Specify "i" and "d"
i min = 5cm d min = 2cm

Standard convertible valves – Z1TLNR

For more information on the choice of valves, see p. 310

	Code	Description	Finishes	Price (€)
	Z1TLNR#ANR12...	Paired Valve + Lockshield - Copper angle 1/2" and/or Multi-layer 1/2"	Standard White Colour C1/C2/C3	
	Z1TLNRG#ANR12..	Paired Valve + Lockshield - Copper angle 1/2" and/or Multi-layer 1/2"	Glossy Chrome	
	Z1KITRAC#001	Union KIT with 6 pieces for Paired valves - 2 Z1RAC#R12CRO 12 mm copper system O-Rings - 2 Z1RAC#R14CRO 14 mm copper system O-Rings - 2 Z1AC#M03CRO Multi-layer 24x19x11.5/12-16x2/2.25 mm	Glossy Chrome	
	ZRCF3#9010	Couple pipe washer for Heated towel rail	Standard White	
	ZRCF3G#CRO	Couple pipe washer for Heated towel rail	Glossy Chrome	

Product code **BA14D#1200500B1ST9010**

- BA14D#120050 Article code specified in the price table
- OB1 Connector code see technical datasheet
- ST Standard support code*
- 9010 Colour/finish code specified in the Official TUBES COLOUR CHART
- * for special supports see BRACKET SUPPORTS page

ADDITIONAL COLOUR CHARGES

Finishes and Anodizing see page. 5 or the colour table provided at the end of this price list.

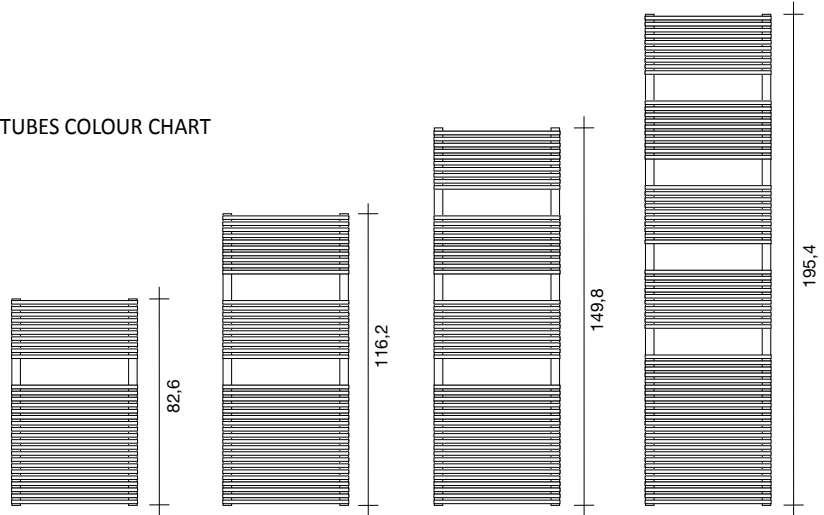

BA14D#... hydraulic

Model	H (cm)	L (cm)	Interaxis (cm)	Heat output in Watts COLOURED version		Price Standard White Cat. C0 (€)	Price Category C1/C2 (€)	Price Category Cat. C3 (€)
				ΔT. 50°C	ΔT. 30°C			
BA14D#080040	82,6	40,0	36,6	650	339			
BA14D#080050	82,6	50,0	46,6	813	424			
BA14D#080060	82,6	60,0	56,6	975	508			
BA14D#120040	116,2	40,0	36,6	832	433			
BA14D#120050	116,2	50,0	46,6	1040	542			
BA14D#120060	116,2	60,0	56,6	1249	651			
BA14D#150040	149,8	40,0	36,6	995	518			
BA14D#150050	149,8	50,0	46,6	1244	648			
BA14D#150060	149,8	60,0	56,6	1493	778			
BA14D#190040	195,4	40,0	36,6	1249	651			
BA14D#190050	195,4	50,0	46,6	1561	813			
BA14D#190060	195,4	60,0	56,6	1874	976			

SIZES AVAILABLE TO ORDER:

All the sizes in WIDTH every 10 cm starting from 70 cm up to 100 cm can be PROVIDED ON DEMAND and the price is calculated upon request.

IN THE PACK

The heated towel rails are supplied with their respective standard supports (code ST), that include the wall fixing shelves, pressure anchors and the respective vent valve, all included inside the pack and included in the price.



STANDARD HYDRAULIC VERSION
(Connectors 0i5)

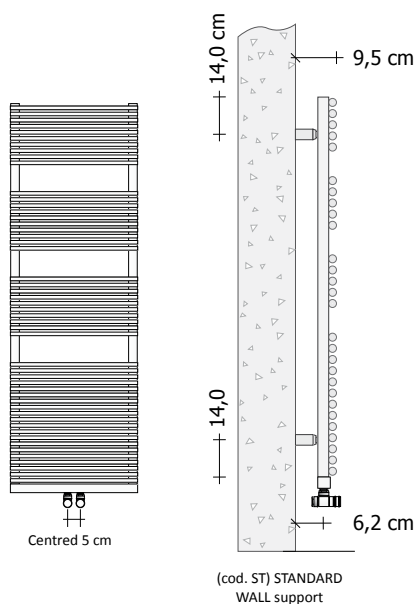

Standard convertible valves – Z1TLNR

For more information on the choice of valves, see p. 310

	Code	Description	Finishes	Price (€)
	Z1TLNR#ANR12...	Paired Valve + Lockshield - Copper angle 1/2" and/or Multi-layer 1/2"	Standard White Colour C1/C2/C3	
	Z1TLNRG#ANR12..	Paired Valve + Lockshield - Copper angle 1/2" and/or Multi-layer 1/2"	Glossy Chrome	
	Z1KITRAC#001	Union KIT with 6 pieces for Paired valves - 2 Z1RAC#R12CRO 12 mm copper system O-Rings - 2 Z1RAC#R14CRO 14 mm copper system O-Rings - 2 Z1AC#M03CRO Multi-layer 24x19x11.5/12-16x2/2.25 mm	Glossy Chrome	
	ZRCF3#9010	Couple pipe washer for Heated towel rail	Standard White	
	ZRCF3G#CRO	Couple pipe washer for Heated towel rail	Glossy Chrome	

Product code **BA14I5#120050I5ST9010**

BA14I5#120050 Article code specified in the price table
 0I5 Connector code
 ST Standard support code*
 9010 Colour/finish code specified in the Official TUBES COLOUR CHART
 * for special supports see BRACKET SUPPORTS page

ADDITIONAL COLOUR CHARGES

Finishes and Anodizing see page. 5 or the colour table provided at the end of this price list.

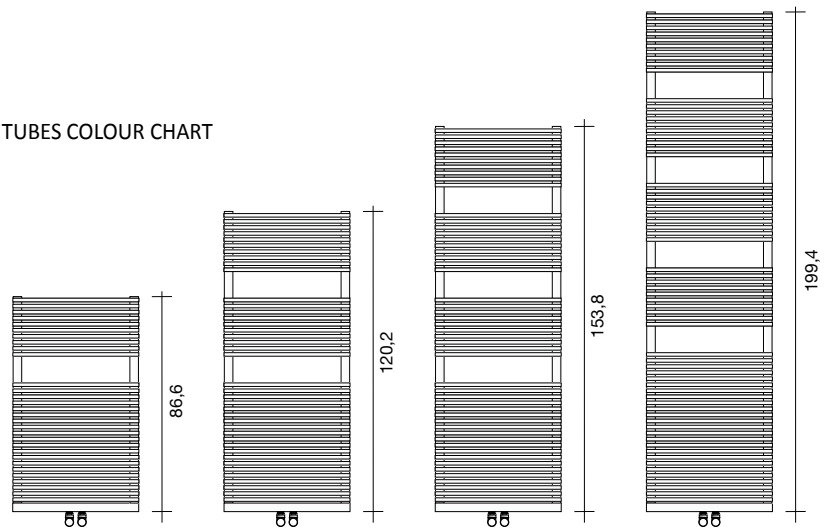

BA14I5#... hydraulic

Model	H (cm)	L (cm)	Interaxis (cm)	Heat output in Watts				Price Standard White Cat. C0 (€)	Price Category C1/C2 (€)	Price Category Cat. C3 (€)	Price Chrome G0 (€)
				COLOURED version		CHROMED version					
				ΔT. 50°C	ΔT. 30°C	ΔT. 50°C	ΔT. 30°C				
BA14I5#080040	86,6	40,0	5,0	367	204	271	142				
BA14I5#080050	86,6	50,0	5,0	459	255	345	182				
BA14I5#080060	86,6	60,0	5,0	550	306	418	222				
BA14I5#120040	120,2	40,0	5,0	488	270	386	204				
BA14I5#120050	120,2	50,0	5,0	610	338	471	250				
BA14I5#120060	120,2	60,0	5,0	732	405	556	297				
BA14I5#150040	153,8	40,0	5,0	598	331	481	249				
BA14I5#150050	153,8	50,0	5,0	747	413	585	306				
BA14I5#150060	153,8	60,0	5,0	896	496	689	363				
BA14I5#190040	199,4	40,0	5,0	781	429	625	323				
BA14I5#190050	199,4	50,0	5,0	977	536	758	394				
BA14I5#190060	199,4	60,0	5,0	1172	643	891	465				

In the Chrome (Plated) Version, code BA14I5 becomes BA14I5G

IN THE PACK

The heated towel rails are supplied with their respective standard supports (code ST), that include the wall fixing shelves, pressure anchors and the respective vent valve, all included inside the pack and included in the price.



STANDARD HYDRAULIC VERSION
(Connectors 0i5)

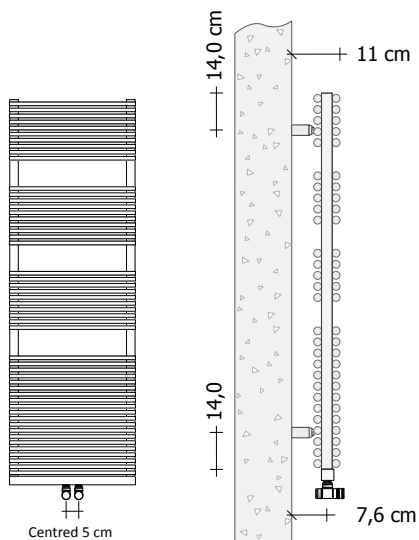

(cod. ST) STANDARD
WALL support

Standard convertible valves – Z1TLNR

For more information on the choice of valves, see p. 310

	Code	Description	Finishes	Price (€)
	Z1TLNR#ANR12...	Paired Valve + Lockshield - Copper angle 1/2" and/or Multi-layer 1/2"	Standard White Colour C1/C2/C3	
	Z1TLNRG#ANR12..	Paired Valve + Lockshield - Copper angle 1/2" and/or Multi-layer 1/2"	Glossy Chrome	
	Z1KITRAC#001	Union KIT with 6 pieces for Paired valves - 2 Z1RAC#R12CRO 12 mm copper system O-Rings - 2 Z1RAC#R14CRO 14 mm copper system O-Rings - 2 Z1AC#M03CRO Multi-layer 24x19x11.5/12-16x2/2.25 mm	Glossy Chrome	
	ZRCF3#9010	Couple pipe washer for Heated towel rail	Standard White	
	ZRCF3G#CRO	Couple pipe washer for Heated towel rail	Glossy Chrome	

Product code **BA14DI5#1200500I5ST9010**

- BA14DI5#120050 Article code specified in the price table
- 0I5 Connector code
- ST Standard support code*
- 9010 Colour/finish code specified in the Official TUBES COLOUR CHART
- * for special supports see BRACKET SUPPORTS page

ADDITIONAL COLOUR CHARGES

Finishes and Anodizing see page. 5 or the colour table provided at the end of this price list.

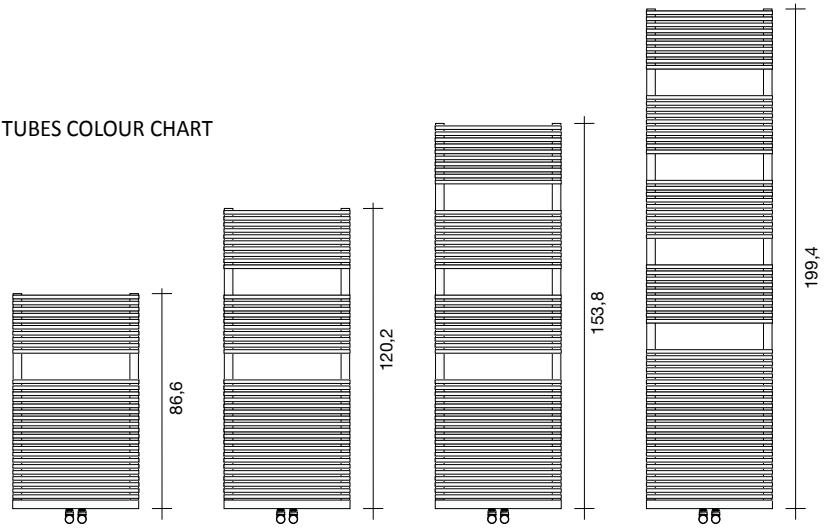

BA14DI5#...hydraulic

Model	H (cm)	L (cm)	Interaxis (cm)	Heat output in Watts COLOURED version		Price Standard White Cat. C0 (€)	Price Category C1/C2 (€)	Price Category Cat. C3 (€)
				ΔT. 50°C	ΔT. 30°C			
BA14DI5#080040	86,6	40,0	5,0	650	339			
BA14DI5#080050	86,6	50,0	5,0	813	424			
BA14DI5#080060	86,6	60,0	5,0	975	508			
BA14DI5#120040	120,2	40,0	5,0	832	433			
BA14DI5#120050	120,2	50,0	5,0	1040	542			
BA14DI5#120060	120,2	60,0	5,0	1249	651			
BA14DI5#150040	153,8	40,0	5,0	995	518			
BA14DI5#150050	153,8	50,0	5,0	1244	648			
BA14DI5#150060	153,8	60,0	5,0	1493	778			
BA14DI5#190040	199,4	40,0	5,0	1249	651			
BA14DI5#190050	199,4	50,0	5,0	1561	813			
BA14DI5#190060	199,4	60,0	5,0	1874	976			

IN THE PACK

The heated towel rails are supplied with their respective standard supports (code ST), that include the wall fixing shelves, pressure anchors and the respective vent valve, all included inside the pack and included in the price.

BATH 14 MIXED STANDARD - B2R - BA14MS (HYDRAULIC/ELECTRIC)

Mixed (hydraulic/electric) heated towel rail radiator made of carbon steel



MIXED VERSION B2R WITH STANDARD EDGE CAP* and Remote GVR connection

(Available only for Extra_CEE market and/or connected to a domestic system with features compliant with the ECODesign standard)

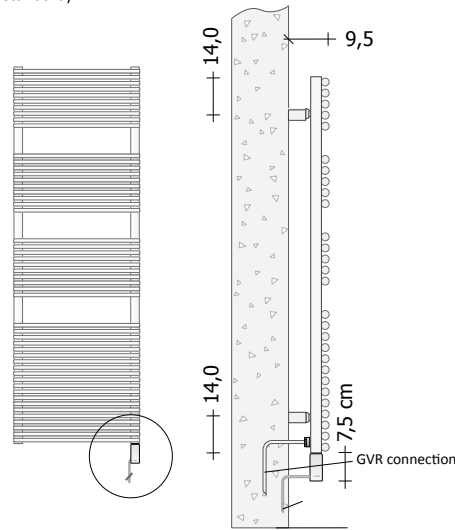

Connection to the electricity mains with Standard Edge Cap



Connection to the electricity mains with DESIGN edge cap painted in the same colour (supplied with an extra charge)

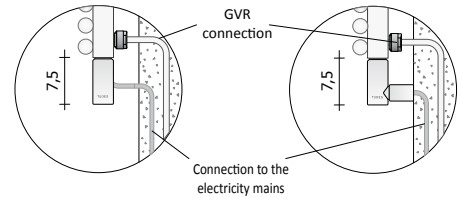

STANDARD MIXED VERSION - B2R - WITH ECODesign THERMOSTAT

Connection via GVR Remote Valve Assembly

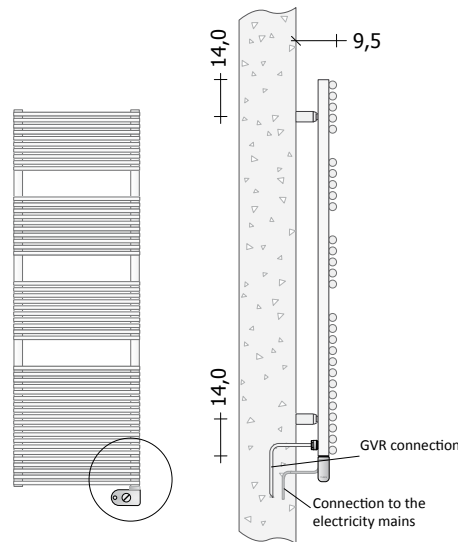

Connection to the electricity mains

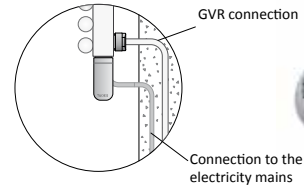

ECODesign Room Thermostat

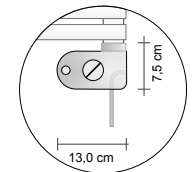

MIXED VERSION B2R WITH WIRELESS ECODesign CONTROLS

Connection via GVR Remote Valve Assembly

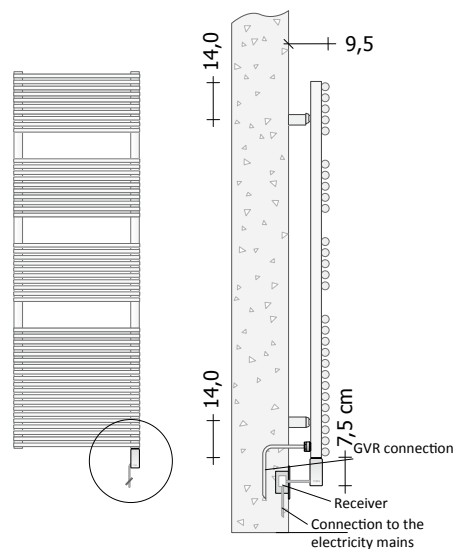

Wireless connection with Standard Edge Cap

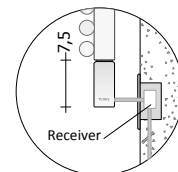

Digital Chronothermostat (code ZRF007)



Wireless connection with DESIGN edge cap painted in the same colour (supplied with an extra charge)

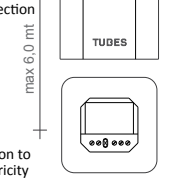
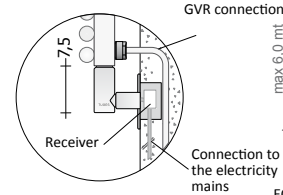

ECODesign digital wireless chronothermostat + Receiver

ADDITIONAL COLOUR CHARGES Finishes and Anodizing see page. 5 or the colour table provided at the end of this price list.

STANDARD B2R MIXED VERSION WITH EDGE CAP

Only available for the extra EEC market and/or connected to a home automation system complying with ECODesign regulations

Version connectable to the GVR via rear connectors.	Colour code of the edge cap				Code DESIGN*	H (cm)	L (cm)	Interaxis (cm)	COLOURED version		CHROMED version		Electrical Resistance (Watts)	Price Standard White Cat. C0 (€)	Price Category C1/C2 (€)	Price Category Cat. C3 (€)	Price Chrome G0 (€)
	White	Anthracite Grey	Chrome	Edge Cap					Watt DT50°C	Watt DT30°C	Watt DT50°C	Watt DT30°C					
BA14MSX#080040	U1	V1	Z1	T6		82,6	40,0	36,6	367	204	271	142	300 W				
BA14MSX#080050	U1	V1	Z1	T6		82,6	50,0	46,6	459	255	345	182	300 W				
BA14MSX#080060	U2	V2	Z2	T8		82,6	60,0	56,6	550	306	418	222	600 W				
BA14MSX#120040	U2	V2	Z2	T8		116,2	40,0	36,6	488	270	386	204	600 W				
BA14MSX#120050	U2	V2	Z2	T8		116,2	50,0	46,6	610	338	471	250	600 W				
BA14MSX#120060	U3	V3	Z3	T9		116,2	60,0	56,6	732	405	556	297	900 W				
BA14MSX#150040	U2	V2	Z2	T8		149,8	40,0	36,6	598	331	481	249	600 W				
BA14MSX#150050	U3	V3	Z3	T9		149,8	50,0	46,6	747	413	585	306	900 W				
BA14MSX#150060	U3	V3	Z3	T9		149,8	60,0	56,6	896	496	689	363	900 W				
BA14MSX#190040	U3	V3	Z3	T9		195,4	40,0	36,6	781	429	625	323	900 W				
BA14MSX#190050	U3	V3	Z3	T9		195,4	50,0	46,6	977	536	758	394	900 W				
BA14MSX#190060	U4	V4	Z4	T0		195,4	60,0	56,6	1172	643	891	465	1200 W				

* The DESIGN EDGE CAP is produced in painted metal in the same Colour/Finish as the towel rail and it does not expose the heating element connection cable, this end piece is supplied upon request with an additional charge of

STANDARD B2R MIXED VERSION WITH ECODesign THERMOSTAT

Version connectable to the GVR via rear connectors.	Thermostat code					H (cm)	L (cm)	Interaxis (cm)	COLOURED version		CHROMED version		Electrical Resistance (Watts)	Price Standard White Cat. C0 (€)	Price Category C1/C2 (€)	Price Category Cat. C3 (€)	Price Chrome G0 (€)
	ROOM*		RADIATOR**						Watt DT50°C	Watt DT30°C	Watt DT50°C	Watt DT30°C					
BA14MST#080040	F5	F7	JO	N1	N5	82,6	40,0	36,6	367	204	271	142	300 W				
BA14MST#080050	F5	F7	JO	N1	N5	82,6	50,0	46,6	459	255	345	182	300 W				
BA14MST#080060	G5	G7	JQ	N2	N6	82,6	60,0	56,6	550	306	418	222	600 W				
BA14MST#120040	G5	G7	JQ	N2	N6	116,2	40,0	36,6	488	270	386	204	600 W				
BA14MST#120050	G5	G7	JQ	N2	N6	116,2	50,0	46,6	610	338	471	250	600 W				
BA14MST#120060	H5	H7	JR	N3	N7	116,2	60,0	56,6	732	405	556	297	900 W				
BA14MST#150040	G5	G7	JQ	N2	N6	149,8	40,0	36,6	598	331	481	249	600 W				
BA14MST#150050	H5	H7	JR	N3	N7	149,8	50,0	46,6	747	413	585	306	900 W				
BA14MST#150060	H5	H7	JR	N3	N7	149,8	60,0	56,6	896	496	689	363	900 W				
BA14MST#190040	H5	H7	JR	N3	N7	195,4	40,0	36,6	781	429	625	323	900 W				
BA14MST#190050	H5	H7	JR	N3	N7	195,4	50,0	46,6	977	536	758	394	900 W				
BA14MST#190060	I5	I7	JS	N4	N8	195,4	60,0	56,6	1172	643	891	465	1200 W				

* In addition to the White finish, the ROOM thermostat is available in the CHROME finish and in the new MATT BLACK finish with an extra charge of € 18.00.

** The RADIATOR thermostat is not ECODesign

STANDARD B2R MIXED VERSION WITH WIRELESS ECODesign CONTROLS

The electric version with WIRELESS control includes the digital Chronothermostat Kit

Version connectable to the GVR via rear connectors.	Colour code of the edge cap				Code DESIGN*	H (cm)	L (cm)	Interaxis (cm)	COLOURED version		CHROMED version		Electrical Resistance (Watts)	Price Standard White Cat. C0 (€)	Price Category C1/C2 (€)	Price Category Cat. C3 (€)	Price Chrome G0 (€)
	White	Anthracite Grey	Chrome	Edge Cap					Watt DT50°C	Watt DT30°C	Watt DT50°C	Watt DT30°C					
BA14MSW#080040	U1	V1	Z1	T6		82,6	40,0	36,6	367	204	271	142	300 W				
BA14MSW#080050	U1	V1	Z1	T6		82,6	50,0	46,6	459	255	345	182	300 W				
BA14MSW#080060	U2	V2	Z2	T8		82,6	60,0	56,6	550	306	418	222	600 W				
BA14MSW#120040	U2	V2	Z2	T8		116,2	40,0	36,6	488	270	386	204	600 W				
BA14MSW#120050	U2	V2	Z2	T8		116,2	50,0	46,6	610	338	471	250	600 W				
BA14MSW#120060	U3	V3	Z3	T9		116,2	60,0	56,6	732	405	556	297	900 W				
BA14MSW#150040	U2	V2	Z2	T8		149,8	40,0	36,6	598	331	481	249	600 W				
BA14MSW#150050	U3	V3	Z3	T9		149,8	50,0	46,6	747	413	585	306	900 W				
BA14MSW#150060	U3	V3	Z3	T9		149,8	60,0	56,6	896	496	689	363	900 W				
BA14MSW#190040	U3	V3	Z3	T9		195,4	40,0	36,6	781	429	625	323	900 W				
BA14MSW#190050	U3	V3	Z3	T9		195,4	50,0	46,6	977	536	758	394	900 W				
BA14MSW#190060	U4	V4	Z4	T0		195,4	60,0	56,6	1172	643	891	465	1200 W				

* The DESIGN EDGE CAP is produced in painted metal in the same Colour/Finish as the towel rail and it does not expose the heating element connection cable, this end piece is supplied upon request with an additional charge of

Remote valve assembly – GVR

For more information on the choice of valves, see p. 310

	Code	Description	Finishes	Price (€)
	GVR#1	RECESSED Valve that can be fitted with a thermostat and Lockshield assembly for REMOTE connection	Chromed Plated	
	GVRTG#1...	RECESSED thermostatic valve and Lockshield assembly for REMOTE connection*		
	GVRC#1...	RECESSED Valve that can be fitted with a thermostat and Lockshield assembly for REMOTE connection	Coloured Coloured	
	GVRTC#1...	RECESSED thermostatic valve and Lockshield assembly for REMOTE connection*		
Plated finishes: See table of Tubes special finishes Colored Finishes: see categories C0, C1, C2 and C3 of the Tubes color chart * The price does not include the cost of the thermostatic head (see page 320)				

IN THE PACK

The heated towel rails are supplied with their respective standard supports (code ST), that include the wall fixing shelves, pressure anchors and the respective vent valve, all included inside the pack and included in the price.

BATH 14 MIXED TRADITIONAL - BA14M (HYDRAULIC/ELECTRIC)

Mixed (hydraulic/electric) heated towel rail radiator made of carbon steel



TRADITIONAL MIXED VERSION WITH EDGE CAP

(Available only for Extra_CEE market and/or connected to a domestic system with features compliant with the ECODesign standard)

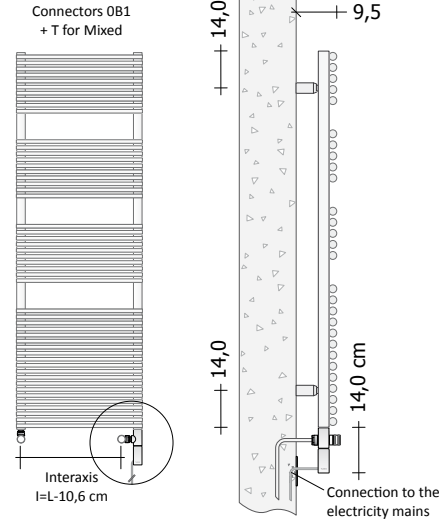

Connection to the electricity mains with Standard Edge Cap



Connection to the electricity mains with DESIGN edge cap painted in the same colour (supplied with an extra charge)

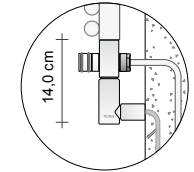
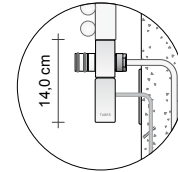

Connection with traditional Valves



TRADITIONAL MIXED VERSION WITH ECODesign THERMOSTAT

Connection with traditional Valves

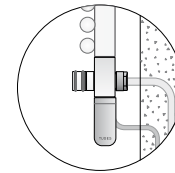
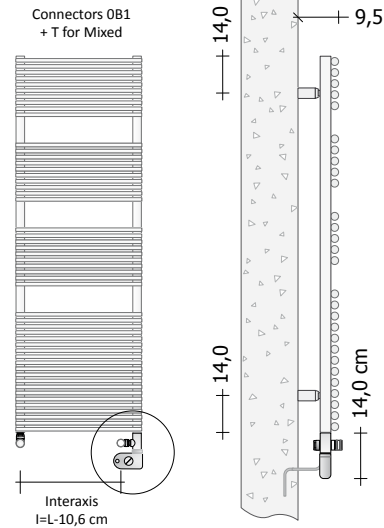

Connection with traditional Valves



ECODesign Room Thermostat

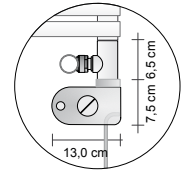

TRADITIONAL MIXED VERSION WITH WIRELESS ECODesign CONTROLS

Connection with traditional Valves

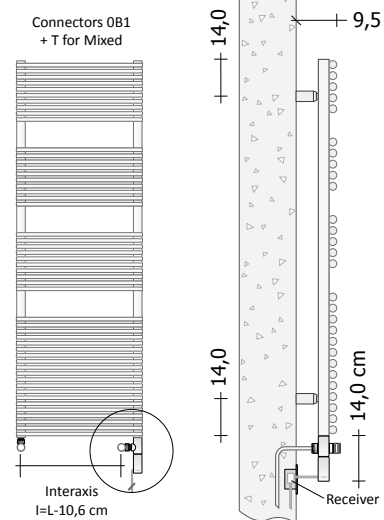

Wireless connection with Standard Edge Cap

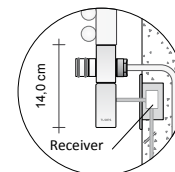

Wireless connection with DESIGN edge cap painted in the same colour (supplied with an extra charge)

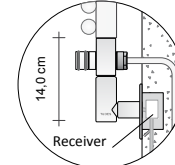

Digital Chronothermostat (code ZRF007)

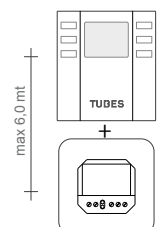

ECODesign digital wireless chronothermostat + Receiver

BASICS BATHROOM HYDRAULIC COLLECTION

Price for Radiator/Towel warmer in Standard White/Chrome color (where specified) and standard connections - VAT and transport excluded.

ADDITIONAL COLOUR CHARGES Finishes and Anodizing see page. 5 or the colour table provided at the end of this price list.

TRADITIONAL MIXED VERSION WITH EDGE CAP (connectable version via kit and traditional valves)

Only available for the extra EEC market and/or connected to a home automation system complying with ECODesign regulations

Version for connection with traditional connectors	Colour code of the edge cap				Code DESIGN* Edge Cap	H (cm)	L (cm)	Interaxis (cm)	COLOURED version		CHROMED version		Electrical Resistance (Watts)	Price Standard White Cat. C0 (€)	Price Category C1/C2 (€)	Price Category Cat. C3 (€)	Price Chrome G0 (€)
	White	Anthracite Grey	Chrome	Edge Cap					Watt DT50°C	Watt DT30°C	Watt DT50°C	Watt DT30°C					
BA14MX#080040	KU1	KV1	KZ1	KT6		82,6	40,0	29,4	367	204	271	142	300 W				
BA14MX#080050	KU1	KV1	KZ1	KT6		82,6	50,0	39,4	459	255	345	182	300 W				
BA14MX#080060	KU2	KV2	KZ2	KT8		82,6	60,0	49,4	550	306	418	222	600 W				
BA14MX#120040	KU2	KV2	KZ2	KT8		116,2	40,0	29,4	488	270	386	204	600 W				
BA14MX#120050	KU2	KV2	KZ2	KT8		116,2	50,0	39,4	610	338	471	250	600 W				
BA14MX#120060	KU3	KV3	KZ3	KT9		116,2	60,0	49,4	732	405	556	297	900 W				
BA14MX#150040	KU2	KV2	KZ2	KT8		149,8	40,0	29,4	598	331	481	249	600 W				
BA14MX#150050	KU3	KV3	KZ3	KT9		149,8	50,0	39,4	747	413	585	306	900 W				
BA14MX#150060	KU3	KV3	KZ3	KT9		149,8	60,0	49,4	896	496	689	363	900 W				
BA14MX#190040	KU3	KV3	KZ3	KT9		195,4	40,0	29,4	781	429	625	323	900 W				
BA14MX#190050	KU3	KV3	KZ3	KT9		195,4	50,0	39,4	977	536	758	394	900 W				
BA14MX#190060	KU4	KV4	KZ4	KTO		195,4	60,0	49,4	1172	643	891	465	1200 W				

* The DESIGN EDGE CAP is produced in painted metal in the same Colour/Finish as the towel rail and it does not expose the heating element connection cable, this end piece is supplied upon request with an additional charge of

TRADITIONAL MIXED VERSION WITH ECODesign THERMOSTAT (connectable version via kit and traditional valves)

Version for connection with traditional connectors	Thermostat code ROOM*			H (cm)	L (cm)	Interaxis (cm)	COLOURED version		CHROMED version		Electrical Resistance (Watts)	Price Standard White Cat. C0 (€)	Price Category C1/C2 (€)	Price Category Cat. C3 (€)	Price Chrome G0 (€)
	White	Chrome	Matt Black				Watt DT50°C	Watt DT30°C	Watt DT50°C	Watt DT30°C					
BA14MT#080040	KF5	KF7	KJO	82,6	40,0	29,4	367	204	271	142	300 W				
BA14MT#080050	KF5	KF7	KJO	82,6	50,0	39,4	459	255	345	182	300 W				
BA14MT#080060	KG5	KG7	KJQ	82,6	60,0	49,4	550	306	418	222	600 W				
BA14MT#120040	KG5	KG7	KJQ	116,2	40,0	29,4	488	270	386	204	600 W				
BA14MT#120050	KG5	KG7	KJQ	116,2	50,0	39,4	610	338	471	250	600 W				
BA14MT#120060	KH5	KH7	KJR	116,2	60,0	49,4	732	405	556	297	900 W				
BA14MT#150040	KG5	KG7	KJQ	149,8	40,0	29,4	598	331	481	249	600 W				
BA14MT#150050	KH5	KH7	KJR	149,8	50,0	39,4	747	413	585	306	900 W				
BA14MT#150060	KH5	KH7	KJR	149,8	60,0	49,4	896	496	689	363	900 W				
BA14MT#190040	KH5	KH7	KJR	195,4	40,0	29,4	781	429	625	323	900 W				
BA14MT#190050	KH5	KH7	KJR	195,4	50,0	39,4	977	536	758	394	900 W				
BA14MT#190060	KI5	KI7	KJS	195,4	60,0	49,4	1172	643	891	465	1200 W				

* In addition to the White finish, the ROOM thermostat is available in the CHROME finish and in the new MATT BLACK finish with an extra charge of € 18.00.

TRADITIONAL MIXED VERSION WITH WIRELESS ECODesign CONTROLS (connectable version via kit and traditional valves)

The electric version with WIRELESS control includes the digital Chronothermostat Kit

Version for connection with traditional connectors	Colour code of the edge cap				Code DESIGN* Edge Cap	H (cm)	L (cm)	Interaxis (cm)	COLOURED version		CHROMED version		Electrical Resistance (Watts)	Price Standard White Cat. C0 (€)	Price Category C1/C2 (€)	Price Category Cat. C3 (€)	Price Chrome G0 (€)
	White	Anthracite Grey	Chrome	Edge Cap					Watt DT50°C	Watt DT30°C	Watt DT50°C	Watt DT30°C					
BA14MW#080040	KU1	KV1	KZ1	KT6		82,6	40,0	29,4	367	204	271	142	300 W				
BA14MW#080050	KU1	KV1	KZ1	KT6		82,6	50,0	39,4	459	255	345	182	300 W				
BA14MW#080060	KU2	KV2	KZ2	KT8		82,6	60,0	49,4	550	306	418	222	600 W				
BA14MW#120040	KU2	KV2	KZ2	KT8		116,2	40,0	29,4	488	270	386	204	600 W				
BA14MW#120050	KU2	KV2	KZ2	KT8		116,2	50,0	39,4	610	338	471	250	600 W				
BA14MW#120060	KU3	KV3	KZ3	KT9		116,2	60,0	49,4	732	405	556	297	900 W				
BA14MW#150040	KU2	KV2	KZ2	KT8		149,8	40,0	29,4	598	331	481	249	600 W				
BA14MW#150050	KU3	KV3	KZ3	KT9		149,8	50,0	39,4	747	413	585	306	900 W				
BA14MW#150060	KU3	KV3	KZ3	KT9		149,8	60,0	49,4	896	496	689	363	900 W				
BA14MW#190040	KU3	KV3	KZ3	KT9		195,4	40,0	29,4	781	429	625	323	900 W				
BA14MW#190050	KU3	KV3	KZ3	KT9		195,4	50,0	39,4	977	536	758	394	900 W				
BA14MW#190060	KU4	KV4	KZ4	KTO		195,4	60,0	49,4	1172	643	891	465	1200 W				

* The DESIGN EDGE CAP is produced in painted metal in the same Colour/Finish as the towel rail and it does not expose the heating element connection cable, this end piece is supplied upon request with an additional charge of

Standard convertible valves – Z1TLNR

For more information on the choice of valves, see p. 310

	Code	Description	Finishes	Price (€)
	Z1TLNR#ANR12...	Paired Valve + Lockshield - Copper angle 1/2" and/or Multi-layer 1/2"	Standard White Colour C1/C2/C3	
	Z1TLNRG#ANR12..	Paired Valve + Lockshield - Copper angle 1/2" and/or Multi-layer 1/2"	Glossy Chrome	
	Z1KITRAC#001	Union KIT with 6 pieces for Paired valves - 2 Z1RAC#R12CRO 12 mm copper system O-Rings - 2 Z1RAC#R14CRO 14 mm copper system O-Rings - 2 Z1AC#M03CRO Multi-layer 24x19x11.5/12-16x2/2.25 mm	Glossy Chrome	
	ZRCF3#9010	Couple pipe washer for Heated towel rail	Standard White	
	ZRCF3G#CRO	Couple pipe washer for Heated towel rail	Glossy Chrome	